

**P5N-E SLI**

**ASUS**<sup>®</sup>

**Motherboard**

**E2968**

**First Edition V2  
December 2006**

Copyright © 2006 ASUSTeK COMPUTER INC. All Rights Reserved.

No part of this manual, including the products and software described in it, may be reproduced, transmitted, transcribed, stored in a retrieval system, or translated into any language in any form or by any means, except documentation kept by the purchaser for backup purposes, without the express written permission of ASUSTeK COMPUTER INC. ("ASUS").

Product warranty or service will not be extended if: (1) the product is repaired, modified or altered, unless such repair, modification or alteration is authorized in writing by ASUS; or (2) the serial number of the product is defaced or missing.

ASUS PROVIDES THIS MANUAL "AS IS" WITHOUT WARRANTY OF ANY KIND, EITHER EXPRESS OR IMPLIED, INCLUDING BUT NOT LIMITED TO THE IMPLIED WARRANTIES OR CONDITIONS OF MERCHANTABILITY OR FITNESS FOR A PARTICULAR PURPOSE. IN NO EVENT SHALL ASUS, ITS DIRECTORS, OFFICERS, EMPLOYEES OR AGENTS BE LIABLE FOR ANY INDIRECT, SPECIAL, INCIDENTAL, OR CONSEQUENTIAL DAMAGES (INCLUDING DAMAGES FOR LOSS OF PROFITS, LOSS OF BUSINESS, LOSS OF USE OR DATA, INTERRUPTION OF BUSINESS AND THE LIKE), EVEN IF ASUS HAS BEEN ADVISED OF THE POSSIBILITY OF SUCH DAMAGES ARISING FROM ANY DEFECT OR ERROR IN THIS MANUAL OR PRODUCT.

SPECIFICATIONS AND INFORMATION CONTAINED IN THIS MANUAL ARE FURNISHED FOR INFORMATIONAL USE ONLY, AND ARE SUBJECT TO CHANGE AT ANY TIME WITHOUT NOTICE, AND SHOULD NOT BE CONSTRUED AS A COMMITMENT BY ASUS. ASUS ASSUMES NO RESPONSIBILITY OR LIABILITY FOR ANY ERRORS OR INACCURACIES THAT MAY APPEAR IN THIS MANUAL, INCLUDING THE PRODUCTS AND SOFTWARE DESCRIBED IN IT.

Products and corporate names appearing in this manual may or may not be registered trademarks or copyrights of their respective companies, and are used only for identification or explanation and to the owners' benefit, without intent to infringe.

# Contents

Notices .....	vii
Safety information .....	viii
About this guide.....	ix
How this guide is organized.....	ix
Where to find more information .....	ix
Conventions used in this guide.....	x
Typography.....	x
P5N-E SLI specifications summary .....	xi

## Chapter 1: Product introduction

1.1	Welcome! .....	1-2
1.2	Package contents .....	1-2
1.3	Special features .....	1-3
1.3.1	Product highlights .....	1-3
1.3.2	Innovative ASUS features .....	1-5
1.4	Before you proceed .....	1-7
1.5	Motherboard overview .....	1-8
1.5.1	Placement direction .....	1-8
1.5.2	Screw holes.....	1-8
1.5.3	Motherboard layout .....	1-9
1.6	Central Processing Unit (CPU) .....	1-10
1.6.1	Installing the CPU.....	1-10
1.6.2	Installing the CPU heatsink and fan.....	1-13
1.6.3	Uninstalling the CPU heatsink and fan.....	1-15
1.7	System memory.....	1-17
1.7.1	Overview .....	1-17
1.7.2	Memory configurations .....	1-17
1.7.3	Installing a DIMM .....	1-21
1.7.4	Removing a DIMM.....	1-21
1.8	Expansion slots .....	1-22
1.8.1	Installing an expansion card .....	1-22
1.8.2	Configuring an expansion card .....	1-22
1.8.3	Interrupt assignments.....	1-23
1.8.4	PCI slots .....	1-24
1.8.5	PCI Express x1 slot .....	1-24

# Contents

- 1.8.6 Two PCI Express x16 slots..... 1-25
- 1.9 Jumpers ..... 1-26
- 1.10 Connectors ..... 1-28
  - 1.10.1 Rear panel connectors ..... 1-28
  - 1.10.2 Internal connectors..... 1-29

## Chapter 2: BIOS setup

- 2.1 Managing and updating your BIOS ..... 2-2
  - 2.1.1 Creating a bootable floppy disk ..... 2-2
  - 2.1.2 Updating the BIOS..... 2-3
  - 2.1.3 Saving the current BIOS file ..... 2-5
  - 2.1.4 ASUS CrashFree BIOS 2 utility ..... 2-6
  - 2.1.5 ASUS EZ Flash2 utility..... 2-8
  - 2.1.6 ASUS Update utility ..... 2-9
- 2.2 BIOS setup program..... 2-12
  - 2.2.1 BIOS menu screen..... 2-13
  - 2.2.2 Menu bar ..... 2-13
  - 2.2.3 Legend bar ..... 2-14
  - 2.2.4 Menu items ..... 2-14
  - 2.2.5 Sub-menu items ..... 2-14
  - 2.2.6 Configuration fields ..... 2-14
  - 2.2.7 Pop-up window..... 2-15
  - 2.2.8 General help ..... 2-15
- 2.3 Main menu..... 2-16
  - 2.3.1 System Time ..... 2-16
  - 2.3.2 System Date ..... 2-16
  - 2.3.3 Legacy Diskette A ..... 2-16
  - 2.3.4 Primary and Secondary IDE Master/Slave ..... 2-17
  - 2.3.5 SATA 1-4 ..... 2-19
  - 2.3.6 HDD SMART Monitoring..... 2-20
  - 2.3.7 Installed Memory..... 2-20
  - 2.3.8 Usable Memory..... 2-20
- 2.4 Advanced menu ..... 2-21
  - 2.4.1 JumperFree Configuration..... 2-21
  - 2.4.2 AI NET2..... 2-25

# Contents

2.4.3	CPU Configuration .....	2-26
2.4.4	Chipset.....	2-27
2.4.5	PCIePnP .....	2-31
2.4.6	Onboard Devices Configuration.....	2-31
2.4.7	USB Configuration .....	2-35
2.5	Power menu .....	2-36
2.5.1	ACPI Suspend Type .....	2-36
2.5.2	ACPI APIC Support Enabled .....	2-36
2.5.3	APM Configuration .....	2-37
2.5.4	Hardware Monitor.....	2-39
2.6	Boot menu .....	2-40
2.6.1	Boot Device Priority .....	2-40
2.6.2	Removable Drives.....	2-41
2.6.3	Boot Settings Configuration .....	2-41
2.6.4	Security.....	2-43
2.7	Tools menu .....	2-44
2.7.1	ASUS O.C. Profile .....	2-45
2.7.2	ASUS EZ Flash 2.....	2-47
2.8	Exit menu.....	2-48

## Chapter 3: Software Support

3.1	Installing an operating system.....	3-2
3.2	Support CD information.....	3-2
3.2.1	Running the support CD .....	3-2
3.2.2	Drivers menu.....	3-3
3.2.3	Utilities menu .....	3-4
3.2.4	Make Disk menu .....	3-5
3.2.5	Manuals menu .....	3-6
3.2.6	ASUS Contact information .....	3-7
3.3	NVIDIA® SLI™ technology .....	3-8
3.3.1	Requirements .....	3-8
3.3.2	Dual graphics card setup .....	3-9
3.4	Creating a RAID driver disk .....	3-16

## Appendix: CPU features

A.1 Intel® EM64T ..... A-1

A.2 Enhanced Intel SpeedStep® Technology (EIST) ..... A-1

    A.2.1 System requirements..... A-1

    A.2.2 Using the EIST ..... A-2

A.3 Intel® Hyper-Threading Technology ..... A-3

# Notices

## Federal Communications Commission Statement

This device complies with Part 15 of the FCC Rules. Operation is subject to the following two conditions:

- This device may not cause harmful interference, and
- This device must accept any interference received including interference that may cause undesired operation.

This equipment has been tested and found to comply with the limits for a Class B digital device, pursuant to Part 15 of the FCC Rules. These limits are designed to provide reasonable protection against harmful interference in a residential installation. This equipment generates, uses and can radiate radio frequency energy and, if not installed and used in accordance with manufacturer's instructions, may cause harmful interference to radio communications. However, there is no guarantee that interference will not occur in a particular installation. If this equipment does cause harmful interference to radio or television reception, which can be determined by turning the equipment off and on, the user is encouraged to try to correct the interference by one or more of the following measures:

- Reorient or relocate the receiving antenna.
- Increase the separation between the equipment and receiver.
- Connect the equipment to an outlet on a circuit different from that to which the receiver is connected.
- Consult the dealer or an experienced radio/TV technician for help.



---

The use of shielded cables for connection of the monitor to the graphics card is required to assure compliance with FCC regulations. Changes or modifications to this unit not expressly approved by the party responsible for compliance could void the user's authority to operate this equipment.

---

## Canadian Department of Communications Statement

This digital apparatus does not exceed the Class B limits for radio noise emissions from digital apparatus set out in the Radio Interference Regulations of the Canadian Department of Communications.

This class B digital apparatus complies with Canadian ICES-003.

# Safety information

## Electrical safety

- To prevent electrical shock hazard, disconnect the power cable from the electrical outlet before relocating the system.
- When adding or removing devices to or from the system, ensure that the power cables for the devices are unplugged before the signal cables are connected. If possible, disconnect all power cables from the existing system before you add a device.
- Before connecting or removing signal cables from the motherboard, ensure that all power cables are unplugged.
- Seek professional assistance before using an adapter or extension cord. These devices could interrupt the grounding circuit.
- Make sure that your power supply is set to the correct voltage in your area. If you are not sure about the voltage of the electrical outlet you are using, contact your local power company.
- If the power supply is broken, do not try to fix it by yourself. Contact a qualified service technician or your retailer.

## Operation safety

- Before installing the motherboard and adding devices on it, carefully read all the manuals that came with the package.
- Before using the product, make sure all cables are correctly connected and the power cables are not damaged. If you detect any damage, contact your dealer immediately.
- To avoid short circuits, keep paper clips, screws, and staples away from connectors, slots, sockets and circuitry.
- Avoid dust, humidity, and temperature extremes. Do not place the product in any area where it may become wet.
- Place the product on a stable surface.
- If you encounter technical problems with the product, contact a qualified service technician or your retailer.



---

The symbol of the crossed out wheeled bin indicates that the product (electrical and electronic equipment) should not be placed in municipal waste. Please check local regulations for disposal of electronic products.

---



# About this guide

This user guide contains the information you need when installing and configuring the motherboard.

## How this guide is organized

This guide contains the following parts:

- **Chapter 1: Product introduction**  
This chapter describes the features of the motherboard and the new technology it supports.
- **Chapter 2: BIOS setup**  
This chapter tells how to change system settings through the BIOS Setup menus. Detailed descriptions of the BIOS parameters are also provided.
- **Chapter 3: Software support**  
This chapter describes the contents of the support CD that comes with the motherboard package.

## Where to find more information

Refer to the following sources for additional information and for product and software updates.

1. **ASUS websites**  
The ASUS website provides updated information on ASUS hardware and software products. Refer to the ASUS contact information.
2. **Optional documentation**  
Your product package may include optional documentation, such as warranty flyers, that may have been added by your dealer. These documents are not part of the standard package.

## Conventions used in this guide

To make sure that you perform certain tasks properly, take note of the following symbols used throughout this manual.



**DANGER/WARNING:** Information to prevent injury to yourself when trying to complete a task.



**CAUTION:** Information to prevent damage to the components when trying to complete a task.



**IMPORTANT:** Instructions that you **MUST** follow to complete a task.



**NOTE:** Tips and additional information to help you complete a task.

## Typography

### **Bold text**

Indicates a menu or an item to select.

### *Italics*

Used to emphasize a word or a phrase.

### <Key>

Keys enclosed in the less-than and greater-than sign means that you must press the enclosed key.

Example: <Enter> means that you must press the Enter or Return key.

### <Key1>+<Key2>+<Key3>

If you must press two or more keys simultaneously, the key names are linked with a plus sign (+).

Example: <Ctrl>+<Alt>+<D>

### **Command**

Means that you must type the command exactly as shown, then supply the required item or value enclosed in brackets.

Example: At the DOS prompt, type the command line:

**awdflash P5N-E SLI.BIN**

## P5N-E SLI specifications summary

<b>CPU</b>	LGA775 socket for Intel® Quad-Core/ Core™ Extreme/ Pentium D/ Pentium® 4/ Celeron® CPU processors Compatible with Intel® 06/05B/05A processors Supports Intel® Enhanced Memory 64 Technology (EM64T) Supports Enhanced Intel SpeedStep® Technology (EIST) Supports Intel® Hyper-Threading Technology
<b>Chipset</b>	North Bridge: NVIDIA nForce® 650i SLI™ (C55) South Bridge: NVIDIA nForce® 430i (MCP 51)
<b>Front Side Bus</b>	1333**/1066/800/533 MHz (** available when CPUs are ready for 1333MHz FSB)
<b>Memory</b>	Dual-channel memory architecture 4 x 240-pin DIMM sockets support unbuffered non-ECC DDR2-800/667/533 memory modules Supports up to 8 GB system memory
<b>Expansion slots</b>	2 x PCI Express x16 slots with Scalable Link Interface (SLI™) support - Single VGA mode: x16 (Default) - SLI mode: x8, x8 1 x PCI Express x1 slot 2 x PCI slots (PCI 2.2)
<b>Audio</b>	Realtek ALC883 6-channel CODEC 1 x Coaxial S/PDIF out port Supports Audio Sensing and Enumeration Technology Supports Multi-Streaming Technology
<b>Storage</b>	NVIDIA nForce® 430i supports: - 2 x Ultra DMA 133/100/66/33 - 4 x Serial ATA 3Gb/s devices - RAID 0, RAID 1, RAID 0+1, RAID 5 and JBOD configuration Jmicron JMB 360 SATA controller supports: - 1 x External Serial ATA 3Gb/s device (SATA On-the-Go)
<b>Gigabit LAN</b>	Marvell 88E1116 PHY Gigabit LAN controller Supports AI NET2 network diagnosis before entering OS

(continued on the next page)

## P5N-E SLI specifications summary

<b>USB</b>	Supports up to 8 USB 2.0 ports
<b>Overclocking features</b>	<p>Intelligent overclocking tool:</p> <ul style="list-style-type: none"> <li>- AI Overclocking (Intelligent CPU Frequency Tuner)</li> </ul> <p>ASUS CPU Lock Free</p> <p>Precision Tweaker supports:</p> <ul style="list-style-type: none"> <li>- vDIMM voltage: 8-step DRAM voltage control</li> <li>- vCore voltage: Adjustable CPU voltage at 6.25mV</li> <li>- vChip voltage: 4-step Chip voltage control</li> </ul> <p>Stepless Frequency Selection (SFS):</p> <ul style="list-style-type: none"> <li>- FSB tuning from 200MHz to 750 MHz at 1MHz increment;</li> <li>- memory tuning from 533MHz to 1200MHz at 1MHz increment;</li> <li>- PCI-E tuning from 100MHz to 131MHz at 1 MHz increment</li> </ul> <p>ASUS CPU Multiplier</p> <p>Overclocking Protection:</p> <ul style="list-style-type: none"> <li>- ASUS C.P.R. (CPU Parameter Recall)</li> </ul>
<b>Special features</b>	<p>ASUS Q-Fan2</p> <p>ASUS Q-Connector</p> <p>ASUS Fanless Design</p> <p>ASUS MyLogo2</p> <p>ASUS O.C. Profile</p> <p>ASUS PC Probe2</p> <p>ASUS Update</p>
<b>BIOS features</b>	4 MB Flash ROM, Award BIOS, PnP, DMI2.0, SM BIOS 2.3, WfM2.0, ASUS EZ Flash 2, ASUS CrashFree BIOS2
<b>Power Requirement</b>	ATX power supply (with 24-pin and 4-pin 12V plugs) ATX 12V 2.0 compliant
<b>Rear panel</b>	<p>1 x Parallel port</p> <p>1 x 1394a connector</p> <p>1 x LAN (RJ-45) ports</p> <p>4 x USB 2.0/1.1 ports</p> <p>1 x Coaxial S/PDIF Out port</p> <p>1 x External SATA</p> <p>1 x PS/2 keyboard port (purple)</p> <p>1 x PS/2 mouse port (green)</p> <p>6-channel audio I/O ports</p>

*(continued on the next page)*

## P5N-E SLI specifications summary

<b>Internal connectors</b>	1 x Floppy disk drive connector 1 x 1394a connector 1 x CD audio in connector 1 x 24-pin ATX power connector 1 x 4-pin ATX 12 V power connector 2 x USB connectors for additional four USB 2.0 ports 1 x S/PDIF out connector 1 x COM Port connector 1 x Chassis intrusion connector 1 x Front panel connector (AAFP) 1 x CPU Fan connector 2 x Chassis fan connectors System panel connector
<b>Manageability</b>	WfM 2.0, DMI 2.0, WOR by Ring, WOL by PME, WOR by PME, WO USB/KB/MS, PXE, RPL&AI Net2
<b>Support CD contents</b>	Device drivers ASUS PC Probe II ASUS Update NV RIS (Remote Installation Service) Microsoft® DirectX 9.0c Anti-Virus Utility (OEM version) Adobe Acrobat Reader v7.0
<b>Form Factor</b>	ATX form factor: 12 in x 9 in (30.5 cm x 22.9 cm)

\* Specifications are subject to change without notice.



This chapter describes the motherboard features and the new technologies it supports.

# 1 Product introduction

## 1.1 Welcome!

Thank you for buying an ASUS® P5N-E SLI motherboard!

The motherboard delivers a host of new features and latest technologies, making it another standout in the long line of ASUS quality motherboards!

Before you start installing the motherboard, and hardware devices on it, check the items in your package with the list below.

## 1.2 Package contents

Check your motherboard package for the following items.

Motherboard		P5N-E SLI
Cables	Serial ATA and power cables	✓
	1 x Ultra DMA 133/100/66 cable	✓
	1 x USB cable 2port	✓
	1 x Floppy disk drive cable	✓
Accessories	I/O shield	✓
	2-in-1 ASUS Q-Connector kit	✓
	1 x SLI soft bridge	✓
Application CD	ASUS motherboard support CD	✓
Documentation	User guide	✓



---

If any of the above items is damaged or missing, contact your retailer.

---



## 1.3 Special features

### 1.3.1 Product highlights

#### LGA775 Intel® Quad-core Processor Ready



This motherboard supports the latest powerful and energy efficient processors from Intel. Intel® Quad-core is based on the Intel Core Microarchitecture process technology that allows users to step up to new levels of gaming experience and multi-tasking performance. Combined with 1066/800 of front side bus (FSB), this motherboard guarantees enhanced user experience in the digital home and office.

#### NVIDIA nForce® 650i SLI™



The NVIDIA® nForce® 650i SLI™ chipset supports the NVIDIA® Scalable Link Interface (SLI™) technology that allows two graphics processing units (GPUs) in a single system. It is a highly integrated, high-performance, cost-effective processor.

#### Intel® Dual-Core Technology CPU support



The motherboard supports dual-core processors containing two physical CPU cores with dedicated L2 caches to meet demands for more powerful processing.

#### Intel® EM64T



The motherboard supports Intel® processors with the Intel® EM64T (Extended Memory 64 Technology). The Intel® EM64T feature allows your computer to run on 64-bit operating systems and access larger amounts of system memory for faster and more efficient computing.

#### Enhanced Intel SpeedStep® Technology (EIST)

The Enhanced Intel SpeedStep® Technology (EIST) intelligently manages the CPU resources by automatically adjusting the CPU voltage and core frequency depending on the CPU loading and system speed or power requirement.

## DDR2 memory support



The motherboard supports DDR2 memory which features data transfer rates of 800 MHz, 667 MHz or 533 MHz to meet the higher bandwidth requirements of the latest 3D graphics, multimedia, and Internet applications. The dual-channel DDR2 architecture doubles the bandwidth of your system memory to boost system performance, eliminating bottlenecks with peak bandwidths of up to 10.7 GB/s. See pages 1-17 to 1-21 for details.

## PCI Express™ interface



The motherboard fully supports PCI Express, the latest I/O interconnect technology that speeds up the PCI bus. PCI Express features point-to-point serial interconnections between devices and allows higher clocks speeds by carrying data in packets. This high speed interface is software compatible with existing PCI specifications. See pages 1-24 and 1-25 for details.

## Gigabit LAN



The Marvell Gigabit LAN controller delivers transfer speeds up to ten times faster than conventional 10/100 Ethernet connections. Gigabit LAN is the networking standard for the early future and is ideal for handling large amounts of data such as video, audio, and voice.

## Serial ATA 3.0 Gb/s technology and SATA on the go



This motherboard supports the next-generation hard drives based on the Serial ATA (SATA) 3Gb/s storage specification, delivering enhanced scalability and doubling the bus bandwidth for high-speed data retrieval and saves. The external SATA port located at the back I/O provides smart setup and hot-plug functions. Easily backup photos, videos and other entertainment contents on external devices. See pages 1-31 and 2-19 for details.

## High Definition Audio



The onboard 6-channel High Definition audio CODEC enables high-quality Realtek ALC883 audio CODEC, which automatically detects and identifies what types of peripherals are plugged into the audio I/O jacks and notifies users of inappropriate connection. See page 1-28 for details.

## S/PDIF digital sound ready



The motherboard supports the S/PDIF technology through the S/PDIF interfaces on the rear panel and at midboard. The S/PDIF technology turns your computer into a high-end entertainment system with digital connectivity to powerful audio and speaker systems. See page 1-28.

## 1.3.2 Innovative ASUS features

### ASUS O.C. Profile

The motherboard features the ASUS O.C. Profile that allows users to conveniently store or load multiple BIOS settings. The BIOS settings can be stored in the CMOS or a separate file, giving users freedom to share and distribute their favorite settings. See pages 2-45 and 2-46 for details.

### CrashFree BIOS 2

This feature allows you to restore the original BIOS data from the support CD in case when the BIOS codes and data are corrupted. This protection eliminates the need to buy a replacement ROM chip. See page 2-6 for details.

### ASUS EZ Flash 2

EZ Flash 2 is a user-friendly BIOS update utility. Simply press the predefined hotkey to launch the utility and update the BIOS without entering the OS. Update your BIOS easily without preparing a bootable diskette or using an OS-based flash utility. See pages 2-8 and 2-47 for details.

### C.P.R. (CPU Parameter Recall)

The C.P.R. feature of the motherboard BIOS allows automatic re-setting to the BIOS default settings in case the system hangs due to overclocking. When the system hangs due to overclocking, C.P.R. eliminates the need to open the system chassis and clear the RTC data. Simply shut down and reboot the system, and the BIOS automatically restores the CPU default setting for each parameter.

### ASUS Q-Connector

ASUS Q-Connector allows you to easily connect or disconnect the chassis front panel cables to the motherboard. This unique module eliminates the trouble of connecting the system panel cables one at a time and avoiding wrong cable connections. See page 1-37 for details.

## Fanless Design



Cooling fans, though a popular thermal solution, also come with noise and malfunction likelihood. ASUS Motherboard's fansless concept is specifically created to provide a cool environment without all the baggage.

ASUS has devoted special efforts to address the thermal issues across the motherboard, and most notably the areas that reside the CPU, power, VGA, Northbridge and Southbridge. The heat sinks and strategic board layout were tailor made to dissipate heat in the most efficient manner.

## AI NET 2



AI NET 2 is a BIOS-based diagnostic tool that detects and reports Ethernet cable faults and shorts. With this utility, you can easily monitor the condition of the Ethernet cable(s) connected to the Marvell LAN (RJ-45) port. During the bootup process, AI NET 2 immediately diagnoses the LAN cable and reports shorts and faults up to 100 meters at 1 meter accuracy. See page 2-25 for details.

## Precision Tweaker



This feature allows you to fine tune the CPU/memory voltage and gradually increase the memory Front Side Bus (FSB) and PCI Express frequency at 1MHz increment to achieve maximum system performance.

## ASUS MyLogo2™



This new feature present in the motherboard allows you to personalize and add style to your system with customizable boot logos. See page 2-42 for details.

## 1.4 Before you proceed

Take note of the following precautions before you install motherboard components or change any motherboard settings.



- Unplug the power cord from the wall socket before touching any component.
- Use a grounded wrist strap or touch a safely grounded object or to a metal object, such as the power supply case, before handling components to avoid damaging them due to static electricity.
- Hold components by the edges to avoid touching the ICs on them.
- Whenever you uninstall any component, place it on a grounded antistatic pad or in the bag that came with the component.
- Before you install or remove any component, ensure that the ATX power supply is switched off or the power cord is detached from the power supply. Failure to do so may cause severe damage to the motherboard, peripherals, and/or components.

### Onboard LED

The motherboard comes with a standby power LED. The green LED lights up to indicate that the system is ON, in sleep mode, or in soft-off mode. This is a reminder that you should shut down the system and unplug the power cable before removing or plugging in any motherboard component. The illustration below shows the location of the onboard LED.

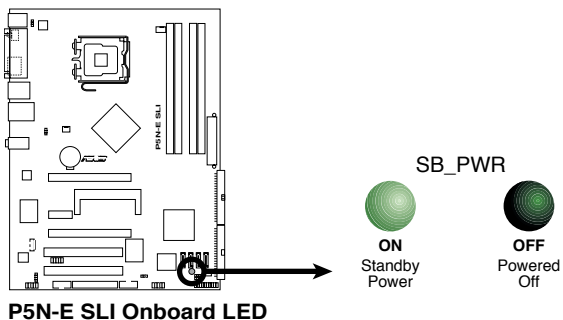

## 1.5 Motherboard overview

Before you install the motherboard, study the configuration of your chassis to ensure that the motherboard fits into it.



Make sure to unplug the power cord before installing or removing the motherboard. Failure to do so can cause you physical injury and damage motherboard components.

### 1.5.1 Placement direction

When installing the motherboard, make sure that you place it into the chassis in the correct orientation. The edge with external ports goes to the rear part of the chassis as indicated in the image below.

### 1.5.2 Screw holes

Place six (6) screws into the holes indicated by circles to secure the motherboard to the chassis.



Do not overtighten the screws! Doing so can damage the motherboard.

Place this side towards the rear of the chassis

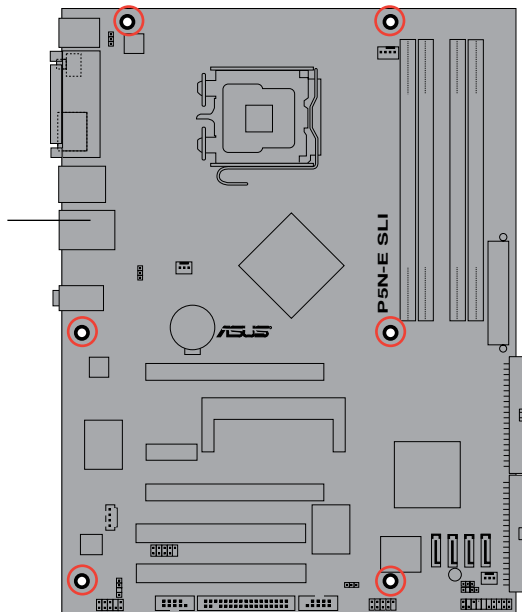

# 1.5.3 Motherboard layout

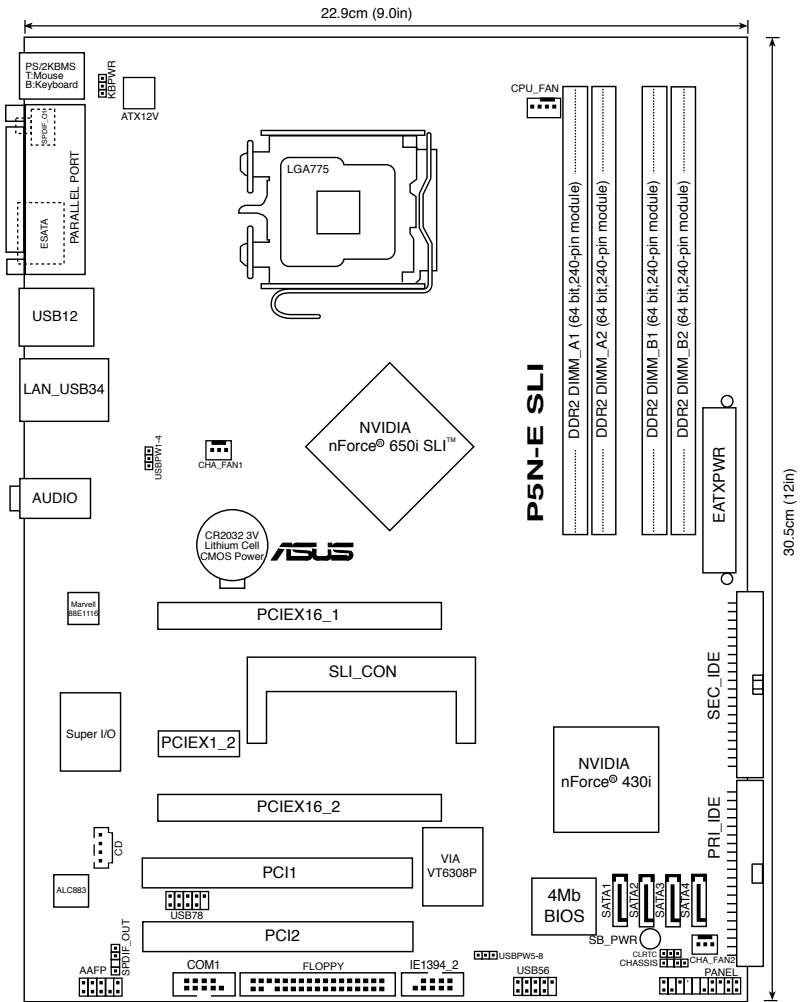

## 1.6 Central Processing Unit (CPU)

The motherboard comes with a surface mount LGA775 designed for the Intel® Quad-Core, Core™2 Extreme, Core™2 Duo, Pentium® Extreme, Pentium® D, Pentium® 4 and Celeron® D processors in the 775-land package.



- Install a chassis fan with at least a speed of 2400 rpm and 8 CFM turnrate when using a dual-core CPU to ensure system stability. Overheating can permanently damage the system and/or CPU.
- Upon purchase of the motherboard, make sure that the PnP cap is on the socket and the socket contacts are not bent. Contact your retailer immediately if the PnP cap is missing, or if you see any damage to the PnP cap/socket contacts/motherboard components. ASUS will shoulder the cost of repair only if the damage is shipment/transit-related.
- Keep the cap after installing the motherboard. ASUS will process Return Merchandise Authorization (RMA) requests only if the motherboard comes with the cap on the LGA775 socket.
- The product warranty does not cover damage to the socket contacts resulting from incorrect CPU installation/removal, or misplacement/loss/incorrect removal of the PnP cap.

### 1.6.1 Installing the CPU

To install a CPU:

1. Locate the CPU socket on the motherboard.

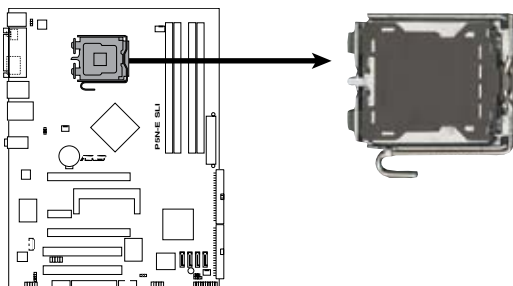

**P5N-E SLI CPU Socket 775**



Before installing the CPU, make sure that the cam box is facing towards you and the load lever is on your left.



2. Press the load lever with your thumb (A), then move it to the left (B) until it is released from the retention tab.

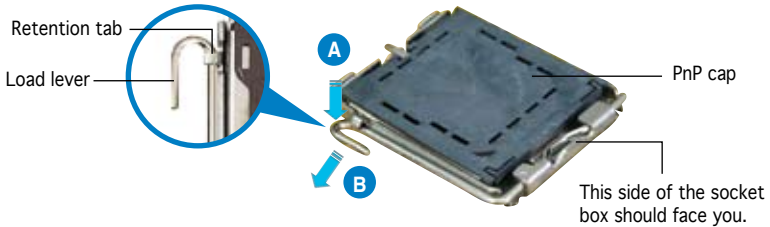

To prevent damage to the socket pins, do not remove the PnP cap unless you are installing a CPU.

3. Lift the load lever in the direction of the arrow to a 135° angle.

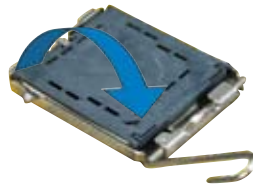

4. Lift the load plate with your thumb and forefinger to a 100° angle (A), then push the PnP cap from the load plate window to remove (B).

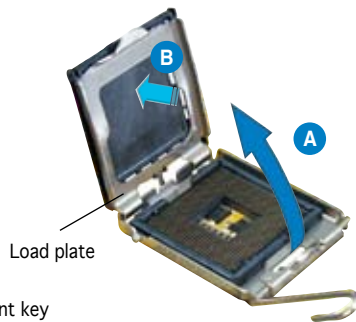

5. Position the CPU over the socket, making sure that the gold triangle is on the bottom-left corner of the socket. The socket alignment key should fit into the CPU notch.

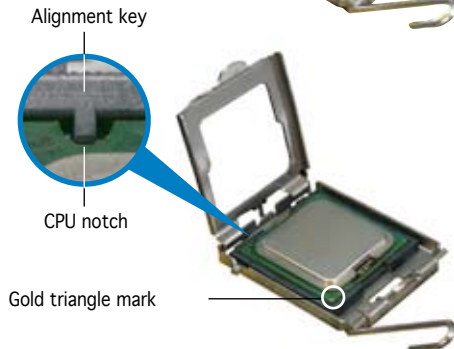



---

The CPU fits in only one correct orientation. DO NOT force the CPU into the socket to prevent bending the connectors on the socket and damaging the CPU!

---

6. Close the load plate (A), then push the load lever (B) until it snaps into the retention tab.



---

The motherboard supports Intel® Pentium® 4 LGA775 processors with the Intel® Enhanced Memory 64 Technology (EM64T), Enhanced Intel SpeedStep® Technology (EIST), and Hyper-Threading Technology.

---

## 1.6.2 Installing the CPU heatsink and fan

Intel® LGA775 processors require a specially designed heatsink and fan assembly to ensure optimum thermal condition and performance.



- When you buy a boxed Intel® processor, the package includes the CPU fan and heatsink assembly. If you buy a CPU separately, make sure that you use only Intel®-certified multi-directional heatsink and fan.
- Your Intel® LGA775 processor heatsink and fan assembly comes in a push-pin design and requires no tool to install.
- If you purchased a separate CPU heatsink and fan assembly, make sure that you have properly applied Thermal Interface Material to the CPU heatsink or CPU before you install the heatsink and fan assembly.



Make sure that you have installed the motherboard to the chassis before you install the CPU fan and heatsink assembly.

To install the CPU heatsink and fan:

1. Place the heatsink on top of the installed CPU, making sure that the four fasteners match the holes on the motherboard.



Orient the heatsink and fan assembly such that the CPU fan cable is closest to the CPU fan connector.

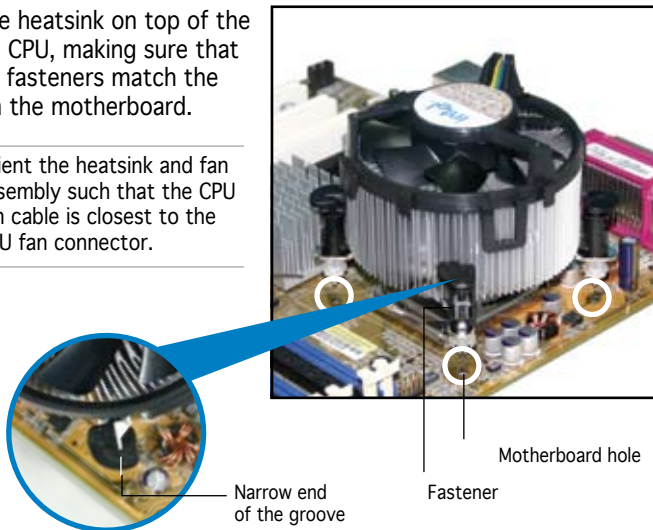

Make sure to orient each fastener with the narrow end of the groove pointing outward. (The photo shows the groove shaded for emphasis.)

2. Push down two fasteners at a time in a diagonal sequence to secure the heatsink and fan assembly in place.

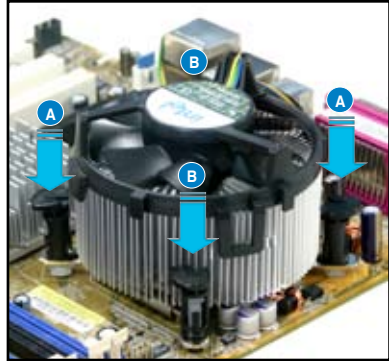
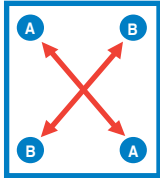

3. Connect the CPU fan cable to the connector on the motherboard labeled CPU\_FAN.

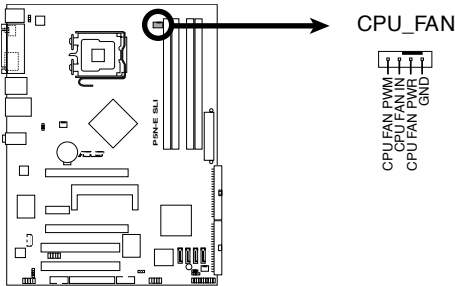

**P5N-E SLI CPU Fan Connector**



- Do not forget to connect the CPU fan connector! Hardware monitoring errors can occur if you fail to plug this connector.
- The retention module of some third-party CPU heatsink and fan can interfere with chipset components at the bottom of the board. Before purchasing a separate CPU heatsink and fan, make sure that it will not interfere with the chipset components.

### 1.6.3 Uninstalling the CPU heatsink and fan

To uninstall the CPU heatsink and fan:

1. Disconnect the CPU fan cable from the connector on the motherboard.
2. Rotate each fastener counterclockwise.

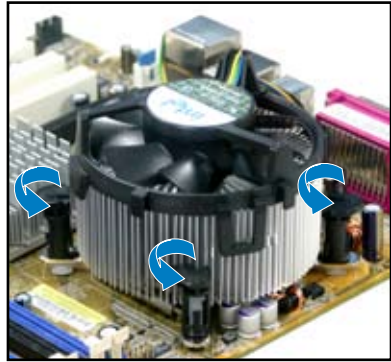

3. Pull up two fasteners at a time in a diagonal sequence to disengage the heatsink and fan assembly from the motherboard.

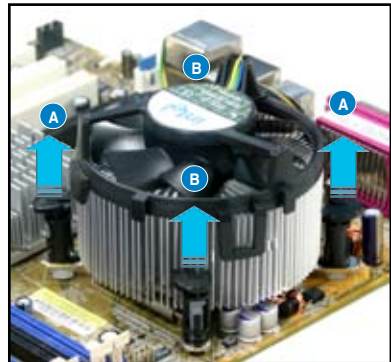
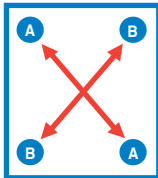

4. Carefully remove the heatsink and fan assembly from the motherboard.



5. Rotate each fastener clockwise to ensure correct orientation when reinstalling.

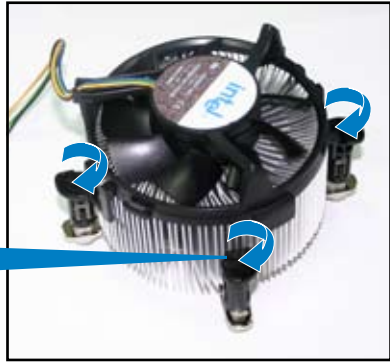

Narrow end of the groove



The narrow end of the groove should point outward after resetting. (The photo shows the groove shaded for emphasis.)



Refer to the documentation in the boxed or stand-alone CPU fan package for detailed information on CPU fan installation.

# 1.7 System memory

## 1.7.1 Overview

The motherboard comes with four Double Data Rate 2 (DDR2) Dual Inline Memory Modules (DIMM) sockets.

A DDR2 module has the same physical dimensions as a DDR DIMM but has a 240-pin footprint compared to the 184-pin DDR DIMM. DDR2 DIMMs are notched differently to prevent installation on a DDR DIMM socket.

The figure illustrates the location of the DDR2 DIMM sockets:

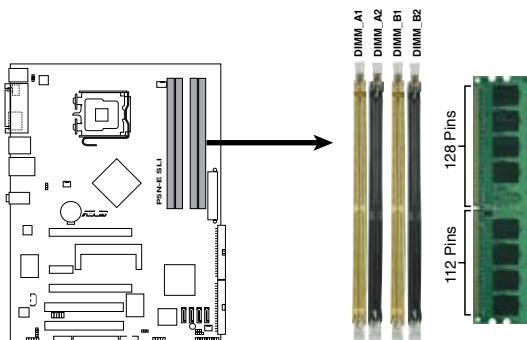

**P5N-E SLI 240-pin DDR2 DIMM Sockets**

Channel	Sockets
Channel A	DIMM_A1 and DIMM_A2
Channel B	DIMM_B1 and DIMM_B2

## 1.7.2 Memory configurations

You may install 256 MB, 512 MB, 1 GB and 2 GB unbuffered non-ECC DDR2 DIMMs into the DIMM sockets.



- For dual-channel configuration, the total size of memory module(s) installed per channel must be the same (DIMM\_A1 + DIMM\_A2 = DIMM\_B1 + DIMM\_B2).
- Always install DIMMs with the same CAS latency. For optimum compatibility, it is recommended that you obtain memory modules from the same vendor. Refer to the DDR2 Qualified Vendors List on the next page for details.
- Due to chipset resource allocation, the system may detect less than 8 GB system memory when you installed four 2 GB DDR2 memory modules.
- If you install four 1GB memory modules, the system may only recognize less than 3 GB because the address space is reserved for other critical functions. This limitation appears on Windows® XP 32-bit operation system which does not support Physical Address Extension (PAE).
- If you install Windows® XP 32-bit operation system, a total memory of less than 3GB is recommended.



## Note on memory limitations

The motherboard can support up to 8 GB on the operating systems listed below. You may install a maximum of 2 GB DIMMs on each slot.

32-bit	64-bit
Windows® 2000 Advanced Server Windows® Server 2003 Enterprise Edition	Windows® Server Standard x64 Edition Windows® XP Professional x64 Edition Windows® Server 2003 Enterprise x64 Edition

## Qualified Vendors Lists (QVL)

### DDR2 with 800 MHz capability

Size	Vendor	Chip No	Side(s)	Part No.	DIMM support		
					A	B	C
512MB	KINGSTON	K4T51083QC	SS	KVR800D2N5/512	•	•	
1024MB	KINGSTON	K4T51083QC	DS	KVR800D2N5/1G	•	•	•
1024MB	KINGSTON	Heat-Sink Package	SS	KHX6400D2LLK2/1GN	•	•	•
512MB	Qimonda	HYB18T256800AF25F	DS	HYS64T64020HU-25F-A	•	•	
256MB	Qimonda	HYB18T512160BF-25F	SS	HYS64T32000HU-25F-B	•	•	
512MB	Qimonda	HYB18T512800BF25F	SS	HYS64T64000HU-25F-B	•	•	•
1024MB	Qimonda	HYB18T512800BF25F	DS	HYS64T128020HU-25F-B	•		
512MB	SAMSUNG	EDD339XX	SS	M378T6553CZ3-CE7	•	•	•
256MB	SAMSUNG	K4T51163QC-ZCE7	SS	M378T3354CZ3-CE7	•	•	•
512MB	SAMSUNG	ZCE7K4T51083QC	SS	M378T6553CZ3-CE7	•	•	•
1024MB	SAMSUNG	ZCE7K4T51083QC	DS	M378T2953CZ3-CE7	•	•	•
512MB	Hynix	HY5PS12821BFP-S5	SS	HYMP564U64BP8-S5		•	•
1024MB	Hynix	HY5PS12821BFP-S5	DS	HYMP512U64BP8-S5	•	•	•
512MB	Hynix	HY5PS12821CFP-S5	SS	HYMP564U64CP8-S5		•	•
1024MB	Hynix	HY5PS12821CFP-S5	DS	HYMP512U64CP8-S5	•	•	
512MB	MICRON	5JAIIZ9DQQ	SS	MT8HTF6464AY-80EA3	•	•	•
1024MB	MICRON	5JAIIZ9DQQ	DS	MT16HTF12864AY-80EA3	•	•	•
512MB	MICRON	5ZD22D9GKX	SS	MT8HTF6464AY-80ED4		•	
1024MB	MICRON	5ZD22D9GKX	DS	MT16HTF12864AY-80ED4	•	•	•
512MB	MICRON	6CD22D9GKX	SS	MT8HTF6464AY-80ED4	•	•	•
1024MB	MICRON	6CD22D9GKX	DS	MT16HTF12864AY-80ED4	•	•	•
1024MB	CORSAIR	Heat-Sink Package	DS	CM2X1024-6400C4	•	•	•
512MB	A-DATA	N/A	SS	M20AD6G3H3160J1E52	•	•	•
512MB	A-DATA	AD29608A8A-25EG	SS	M20AD6G3H3160I1E5E	•	•	•
1024MB	A-DATA	AD29608A8A-25EG	DS	M20AD6G3I4170G1E53		•	•
512MB	Crucial	Heat-Sink Package	SS	BL6464AA804.8FD	•	•	•
1024MB	Crucial	Heat-Sink Package	DS	BL12864AA804.16FD	•	•	•
512MB	Transcend	K4T51083QC	SS	TS64MLQ64V8J	•	•	•
1024MB	Transcend	K4T51083QC	DS	TS128MLQ64V8J	•	•	•



## DDR2 with 667 MHz capability

Size	Vendor	Chip No	Side(s)	Part No.	DIMM support		
					A	B	C
256MB	KINGSTON	HYB18T256800AF3	SS	KVR667D2N5/256			•
256MB	KINGSTON	HYB18T256800AF3S	SS	KVR667D2N5/256			•
256MB	Qimonda	HYB18T512160AF-3S	SS	HYS64T32000HU-3S-A			•
256MB	Qimonda	HYB18T512160BF-3S	SS	HYS64T32000HU-3S-B	•	•	•
512MB	Qimonda	HYB18T512800BF3S	SS	HYS64T64000HU-3S-B	•	•	•
1024MB	Qimonda	HYB18T512800BF3S	DS	HYS64T128020HU-3S-B	•	•	•
256MB	SAMSUNG	K4T51163QC-ZCE6	SS	M378T3354CZ0-CE6	•	•	
512MB	SAMSUNG	ZCE6K4T51083QC	SS	M378T6553CZ0-CE6	•	•	•
256MB	SAMSUNG	K4T51163QC-ZCE6	SS	M378T3354CZ3-CE6	•	•	•
512MB	SAMSUNG	K4T51083QC	SS	M378T6553CZ3-CE6	•	•	•
1024MB	SAMSUNG	ZCE6K4T51083QC	DS	M378T2953CZ3-CE6	•		•
1024MB	Apacer	AM4B5708GQJ57E	DS	AU01GE667C5KBGC	•	•	•
512MB	Kingmax	KKEA88B4LAUG-29DX	SS	KLCC28F-A8KB5		•	•
512MB	Transcend	E5108AE-6E-E	SS	TS64MLQ64V6J	•	•	•
1024MB	Transcend	E5108AE-6E-E	DS	TS128MLQ64V6J	•	•	•
512MB	Super Talent	Heat-Sink Package	SS	T6UA512C5			•

## DDR2 with 533 MHz capability

Size	Vendor	Chip No.	Side(s)	Part No.	DIMM support		
					A	B	C
256MB	KINGSTON	E5116AF-5C-E	SS	KVR533D2N4/256	•	•	•
512MB	KINGSTON	HYB18T512800AF37	SS	KVR533D2N4/512	•	•	•
1024MB	KINGSTON	5YDID9GCT	DS	KVR533D2N4/1G	•	•	
256MB	Qimonda	HYB18T512160AF-3.7	SS	HYS64T32000HU-3.7-A	•	•	•
512MB	Qimonda	HYB18T512800AF37	SS	HYS64T64000HU-3.7-A	•	•	•
1024MB	Qimonda	HYB18T512800AF37	DS	HYS64T128020HU-3.7-A	•	•	•
2048MB	Qimonda	HYB18T1G800AF-3.7	DS	HYS64T256020HU-3.7-A	•	•	
256MB	Qimonda	HYB18T5121608BF-3.7	SS	HYS64T32000HU-3.7-B	•	•	•
512MB	Qimonda	HYB18T512800BF37	SS	HYS64T64000HU-3.7-B	•	•	•
1024MB	Qimonda	HYB18T512800BF37	DS	HYS64T128020HU-3.7-B	•	•	•
256MB	Qimonda	HYB18T256800AF37(ECC)	SS	HYS72T32000HU-3.7-A	•	•	•
1024MB	Qimonda	HYB18T512800AF37(ECC)	DS	HYS72T128020HU-3.7-A	•	•	•
256MB	SAMSUNG	K4T51163QC-ZCD5	SS	M378T3354CZ3-CD5	•	•	•
512MB	SAMSUNG	ZCD5K4T51083QC	SS	M378T6553CZ3-CD5	•	•	•
1024MB	SAMSUNG	ZCD5K4T51083QC	DS	M378T2953CZ3-CD5	•	•	•
512MB	Hynix	HY5PS12821F-C4	SS	HYMP564U648-C4	•	•	•
512MB	Hynix	HY5PS12821F-C4(ECC)	SS	HYMP564U728-C4	•	•	•
1024MB	Hynix	HY5PS12821F-C4	DS	HYMP512U648-C4	•	•	•
1024MB	Hynix	HY5PS12821F-C4(ECC)	DS	HYMP512U728-C4	•	•	•
512MB	Hynix	HY5PS12821FP-C4(ECC)	SS	HYMP564U728-C4	•	•	•
1024MB	Hynix	HY5PS12821FP-C4	DS	HYMP512U648-C4	•	•	•
512MB	Hynix	HY5PS12821AFP-C3	SS	HYMP564U64AP8-C3	•	•	•
1024MB	Hynix	HY5PS12821AFP-C3	DS	HYMP512U64AP8-C3	•	•	•
1024MB	CORSAIR	64M8CEDG	DS	VS1GB533D2	•	•	•
512MB	ELPIDA	E5108AB-5C-E	SS	EBE51UD8ABFA-5C	•	•	
512MB	ELPIDA	E5108AB-5C-E	SS	EBE51UD8ABFA-5C-E	•	•	•
1024MB	ELPIDA	E5108AB-5C-E	DS	EBE11UD8ABFA-5C-E	•	•	
512MB	KINGMAX	E5108AE-5C-E	SS	KLBC28F-A8EB4	•	•	•
1024MB	KINGMAX	E5108AE-5C-E	DS	KLBD48F-A8EB4	•	•	•
512MB	KINGMAX	KKEA88E4AAK-37	SS	KLBC28F-A8EK4	•	•	•
1024MB	KINGMAX	5MB22D9DCN	DS	KLBD48F-A8ME4	•	•	•
512MB	Super Talent	Heat-Sink Package	SS	TSUA512C4	•	•	•
1024MB	Super Talent	Heat-Sink Package	DS	T5UB1G8C4	•	•	•



Visit the ASUS website ([www.asus.com](http://www.asus.com)) for the latest QVL.

Side(s): SS - Single-sided DS - Double-sided

DIMM support:

- A - Supports one module inserted into either slot, in Single-channel memory configuration.
- B - Supports one pair of modules inserted into either the blue slots or the black slots as one pair of Dual-channel memory configuration.
- C - Supports two pairs of modules inserted into the blue and black slots as two pairs of Dual-channel memory configuration.

### 1.7.3 Installing a DIMM



Unplug the power supply before adding or removing DIMMs or other system components. Failure to do so can cause severe damage to both the motherboard and the components.

To install a DIMM:

1. Unlock a DIMM socket by pressing the retaining clips outward.
2. Align a DIMM on the socket such that the notch on the DIMM matches the break on the socket.
3. Firmly insert the DIMM into the socket until the retaining clips snap back in place and the DIMM is properly seated.

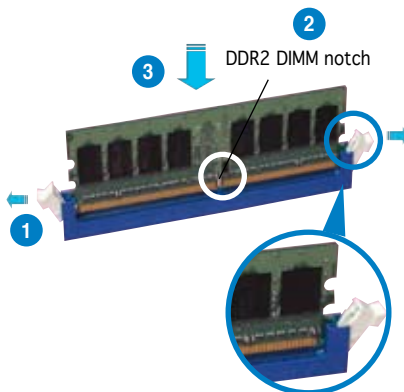

Unlocked retaining clip



- A DDR2 DIMM is keyed with a notch so that it fits in only one direction. Do not force a DIMM into a socket to avoid damaging the DIMM.
- The DDR2 DIMM sockets do not support DDR DIMMs. DO not install DDR DIMMs to the DDR2 DIMM sockets.

### 1.7.4 Removing a DIMM

Follow these steps to remove a DIMM.

1. Simultaneously press the retaining clips outward to unlock the DIMM.



Support the DIMM lightly with your fingers when pressing the retaining clips. The DIMM might get damaged when it flips out with extra force.

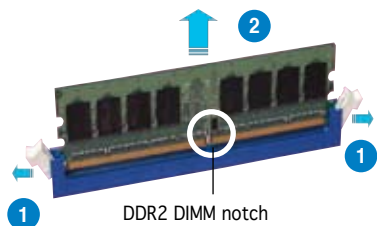

2. Remove the DIMM from the socket.

## 1.8 Expansion slots

In the future, you may need to install expansion cards. The following sub-sections describe the slots and the expansion cards that they support.



---

Make sure to unplug the power cord before adding or removing expansion cards. Failure to do so may cause you physical injury and damage motherboard components.

---

### 1.8.1 Installing an expansion card

To install an expansion card:

1. Before installing the expansion card, read the documentation that came with it and make the necessary hardware settings for the card.
2. Remove the system unit cover (if your motherboard is already installed in a chassis).
3. Remove the bracket opposite the slot that you intend to use. Keep the screw for later use.
4. Align the card connector with the slot and press firmly until the card is completely seated on the slot.
5. Secure the card to the chassis with the screw you removed earlier.
6. Replace the system cover.

### 1.8.2 Configuring an expansion card

After installing the expansion card, configure the it by adjusting the software settings.

1. Turn on the system and change the necessary BIOS settings, if any. See Chapter 2 for information on BIOS setup.
2. Assign an IRQ to the card. Refer to the tables on the next page.
3. Install the software drivers for the expansion card.



---

When using PCI cards on shared slots, ensure that the drivers support “Share IRQ” or that the cards do not need IRQ assignments. Otherwise, conflicts will arise between the two PCI groups, making the system unstable and the card inoperable. Refer to the table on the next page for details.

---

## 1.8.3 Interrupt assignments

### Standard interrupt assignments

IRQ	Priority	Standard Function
0	1	System Timer
1	2	Keyboard Controller
2	—	Re-direct to IRQ#9
4	12	Communications Port (COM1)*
5	13	IRQ holder for PCI steering*
6	14	Floppy Disk Controller
7	15	Printer Port (LPT1)*
8	3	System CMOS/Real Time Clock
9	4	IRQ holder for PCI steering*
10	5	IRQ holder for PCI steering*
11	6	IRQ holder for PCI steering*
12	7	PS/2 Compatible Mouse Port*
13	8	Numeric Data Processor
14	9	Primary IDE Channel
15	10	Secondary IDE Channel

\* These IRQs are usually available for ISA or PCI devices.

### IRQ assignments for this motherboard

	A	B	C	D	E	F	G	H
PCI Express x16 slot 1	—	—	—	—	shared	—	—	—
PCI Express x16 slot 2	—	—	—	—	shared	—	—	—
PCI Express x1 slot 1	—	—	—	—	—	—	shared	—
PCI slot 1	shared	—	—	—	—	—	—	—
PCI slot 2	—	shared	—	—	—	—	—	—
Onboard 1394	—	—	shared	—	—	—	—	—
Onboard Ext SATA	—	—	—	—	—	shared	—	—
Onboard USB1.0 controller	—	shared	—	—	—	—	—	—
Onboard USB2.0 controller	—	—	—	—	—	—	—	shared
Onboard SATA0 controller	shared	—	—	—	—	—	—	—
Onboard SATA1 controller	—	—	—	—	—	—	—	shared
Onboard LAN	shared	—	—	—	—	—	—	—
Onboard IDE controller	shared	—	—	—	—	—	—	—
Onboard Audio controller	shared	—	—	—	—	—	—	—

### 1.8.4 PCI slots

The PCI slots support cards such as a LAN card, SCSI card, USB card, and other cards that comply with PCI specifications. The figure shows a LAN card installed on a PCI slot.

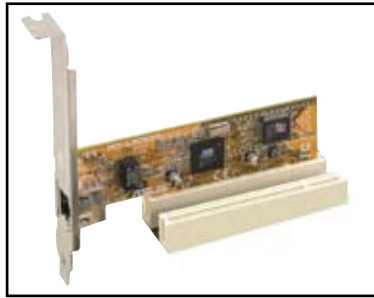

### 1.8.5 PCI Express x1 slot

This motherboard supports PCI Express x1 network cards, SCSI cards and other cards that comply with the PCI Express specifications. The figure shows a network card installed on the PCI Express x1 slot.

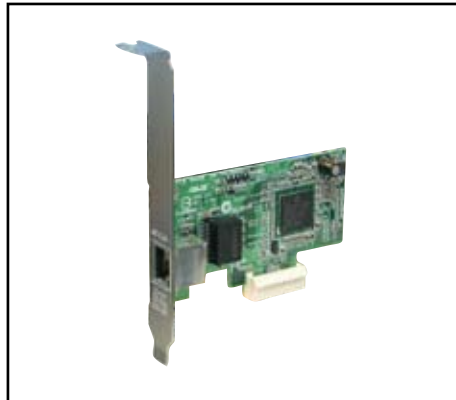

## 1.8.6 Two PCI Express x16 slots

This motherboard supports one PCI Express x16 graphics card or two SLI-ready PCI Express x16 graphic cards that comply with the PCI Express specifications. The figure shows a graphics card installed on the PCI Express x16 slot.



Install a rear chassis fan to the chassis (CHA\_FAN) connector when using two graphics cards for better thermal environment. See page 1-32 for details.



- In Single Card mode, only the PCI Express blue slot can be used for PCI Express x16 graphics cards.
- In SLI mode, the PCI Express x16 slots work at the bandwidth of PCI Express x8. The combined bandwidth of these maintain the bandwidth of PCI Express x16.
- See the table below for possible PCI Express card configurations.

### PCI Express x16 slot configurations

EZ Selector setting		PCIEX16_1 (blue) slot		PCIEX16_2 (black) slot	
		Card Type	Speed	Card Type	Speed
Single Video Card		Qualified PCIe x16 graphics card	x16		
Dual Video Cards	SLI mode	Qualified SLI-ready graphics cards	x8	Qualified SLI-ready graphics card	x8
	Multi-monitor, RAID or LAN setup	Qualified PCIe x16 graphics card	x8	Qualified PCIe graphics card, RAID or LAN card	x8, x4, x2, x1

## 1.9 Jumpers

### 1. Clear RTC RAM (CLRTC)

This jumper allows you to clear the Real Time Clock (RTC) RAM in CMOS. You can clear the CMOS memory of date, time, and system setup parameters by erasing the CMOS RTC RAM data. The onboard button cell battery powers the RAM data in CMOS, which include system setup information such as system •words.

To erase the RTC RAM:

1. Turn OFF the computer and unplug the power cord.
2. Remove the onboard battery.
3. Move the jumper cap from pins 1-2 (default) to pins 2-3. Keep the cap on pins 2-3 for about 5~10 seconds, then move the cap back to pins 1-2.
4. Re-install the battery.
5. Plug the power cord and turn ON the computer.
6. Hold down the <Del> key during the boot process and enter BIOS setup to re-enter data.



---

Except when clearing the RTC RAM, never remove the cap on CLRTC jumper default position. Removing the cap will cause system boot failure!

---

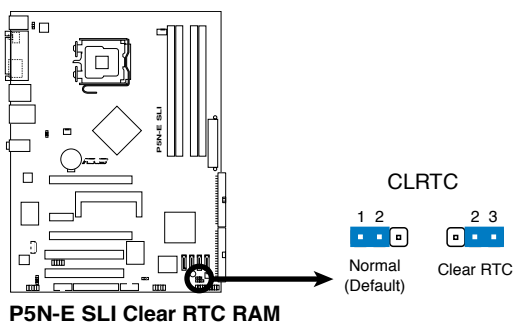

- Make sure to re-enter your previous BIOS settings after you clear the CMOS.
  - You do not need to clear the RTC when the system hangs due to overclocking. For system failure due to overclocking, use the C.P.R. (CPU Parameter Recall) feature. Shut down and reboot the system so the BIOS can automatically reset parameter settings to default values.
-



## 2. USB device wake-up (3-pin USBPW1-4, USBPW5-8)

Set these jumpers to +5V to wake up the computer from S1 sleep mode (CPU stopped, DRAM refreshed, system running in low power mode) using the connected USB devices. Set to +5V<sub>SB</sub> to wake up from S3 and S4 sleep modes (no power to CPU, DRAM in slow refresh, power supply in reduced power mode).

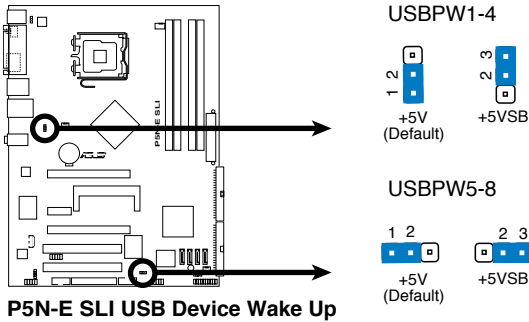

- The USB device wake-up feature requires a power supply that can provide 500mA on the +5V<sub>SB</sub> lead for each USB port; otherwise, the system would not power up.
- The total current consumed must NOT exceed the power supply capability (+5V<sub>SB</sub>) whether under normal condition or in sleep mode.

## 3. Keyboard power (3-pin KBPWR)

This jumper allows you to enable or disable the keyboard wake-up feature. Set this jumper to pins 2-3 (+5V<sub>SB</sub>) to wake up the computer when you press a key on the keyboard (the default is the Space Bar). This feature requires an ATX power supply that can supply at least 1A on the +5V<sub>SB</sub> lead, and a corresponding setting in the BIOS.

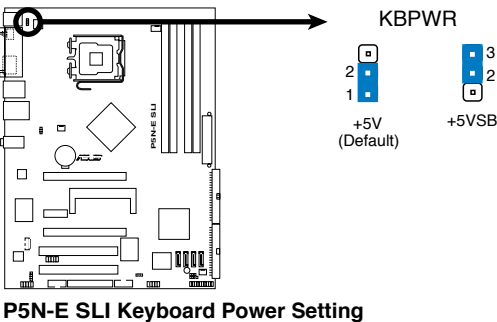

## 1.10 Connectors

### 1.10.1 Rear panel connectors

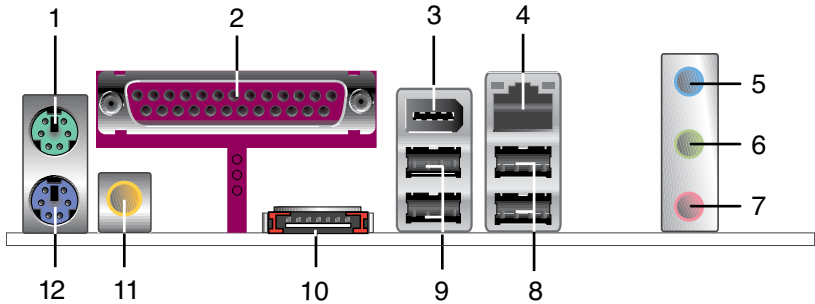

1. **PS/2 mouse port (green).** This port is for a PS/2 mouse.
2. **Parallel port.** This 25-pin port connects a parallel printer, a scanner, or other devices.
3. **IEEE 1394a port.** This 6-pin IEEE 1394 port provides high-speed connectivity for audio/video devices, storage peripherals, PCs, or portable devices.
4. **LAN (RJ-45) port.** Supported by Marvell® 88E1116 Gigabit LAN controller, this port allows Gigabit connection to a Local Area Network (LAN) through a network hub. Refer to the table below for the LAN port LED indications.

LAN port LED indications

ACT/LINK LED		SPEED LED	
Status	Description	Status	Description
OFF	No link	OFF	10 Mbps connection
ORANGE	Linked	ORANGE	100 Mbps connection
BLINKING	Data activity	GREEN	1 Gbps connection

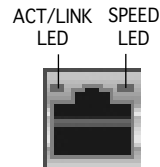

LAN port

5. **Line In port (light blue).** This port connects the tape, CD, DVD player, or other audio sources.
6. **Line Out port (lime).** This port connects a headphone or a speaker. In 4-channel, and 6-channel configuration, the function of this port becomes Front Speaker Out.
7. **Microphone port (pink).** This port connects a microphone.



Refer to the audio configuration table below for the function of the audio ports in 2, 4, or 6-channel configuration.

## Audio 2, 4, or 6-channel configuration

Port	Headset 2-channel	4-channel	6-channel
Light Blue	Line In	Rear Speaker Out	Surround
Lime	Line Out	Front Speaker Out	Front Speaker Out
Pink	Mic In	Mic In	Center/Bass

- 8. USB 2.0 ports 3 and 4.** These two 4-pin Universal Serial Bus (USB) ports are available for connecting USB 2.0 devices.
- 9. USB 2.0 ports 1 and 2.** These two 4-pin Universal Serial Bus (USB) ports are available for connecting USB 2.0 devices.
- 10. External SATA port.** This port connects to an Serial ATA hard disk drive.
- 11. Coaxial S/PDIF Out port.** This port connects an external audio output device via a coaxial S/PDIF cable.
- 12. PS/2 keyboard port (purple).** This port is for a PS/2 keyboard.

### 1.10.2 Internal connectors

#### 1. Floppy disk drive connector (34-1 pin FLOPPY)

This connector is for the provided floppy disk drive (FDD) signal cable. Insert one end of the cable to this connector, then connect the other end to the signal connector at the back of the floppy disk drive.



Pin 5 on the connector is removed to prevent incorrect cable connection when using a FDD cable with a covered Pin 5.

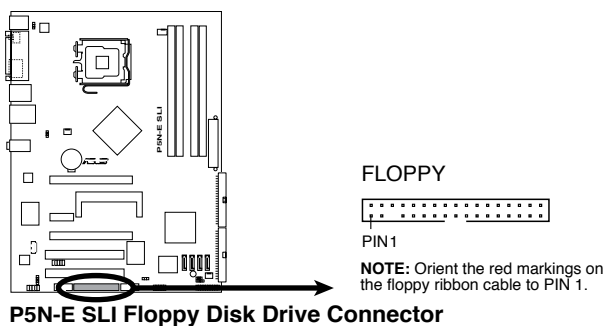

## 2. IDE connector (40-1 pin PRI\_IDE, SEC\_IDE)

The onboard IDE connector is for the Ultra DMA 133/100/66/33 signal cable. There are four connectors on each Ultra DMA 133/100/66/33 signal cable: blue, black, and gray. Connect the blue connector to the motherboard's IDE connector, then select one of the following modes to configure your device.

	Drive jumper setting	Mode of device(s)	Cable connector
Single device	Cable-Select or Master	-	Black
Two devices	Cable-Select	Master	Black
		Slave	Gray
	Master	Master	Black or gray
	Slave	Slave	



- Pin 20 on the IDE connector is removed to match the covered hole on the Ultra DMA cable connector. This prevents incorrect insertion when you connect the IDE cable.
- Use the 80-conductor IDE cable for Ultra DMA 133/100/66/33 IDE devices.



If any device jumper is set as “Cable-Select,” make sure all other device jumpers have the same setting.

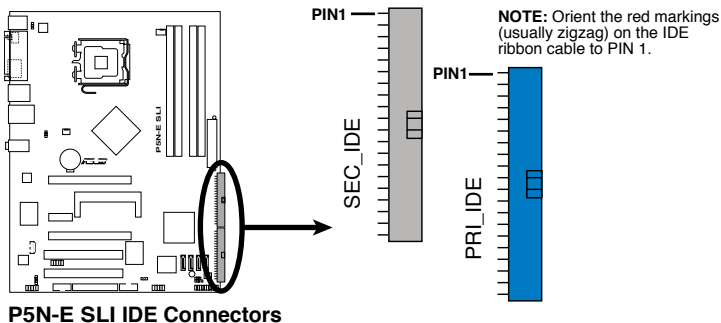

### 3. Serial ATA connectors (7-pin SATA1 [red], SATA2 [black], SATA3 [red], SATA4 [black])

These connectors are for the Serial ATA signal cables for Serial ATA hard disk and optical disk drives.



- These connectors are Disabled by default. If you intend to create a Serial ATA RAID set using these connectors, enable the First, Second, Third or Fourth SATA Master RAID items in **Advanced > Onboard Devices Configuration > NVRAID Configuration** of the BIOS. See section “2.4.6 Onboard Devices Configuration” on page 2-30 for details.

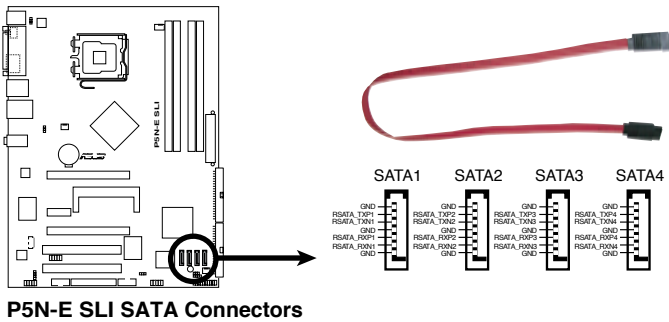

**P5N-E SLI SATA Connectors**



These connectors support Native Command Queuing (NCQ), Power Management (PM) Implementation Algorithm, Hot Swap and smart setup.

### 4. Audio connectors (4-pin CD)

These connectors allow you to receive stereo audio input from sound sources such as a CD-ROM, TV-tuner, or MPEG card.

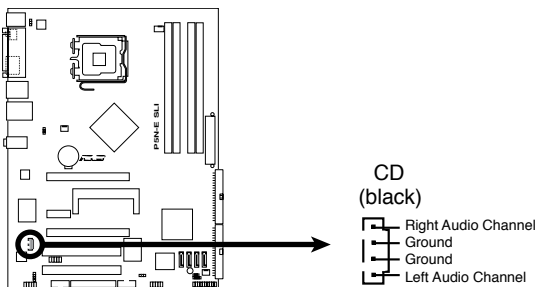

**P5N-E SLI Internal Audio Connector**

## 5. USB connectors (10-1 pin USB56, USB78)

These connectors are for USB 2.0 ports. Connect the USB module cable to any of these connectors, then install the module to a slot opening at the back of the system chassis. These USB connectors comply with USB 2.0 specification that supports up to 480 Mbps connection speed.



On WiFi model, the onboard WiFi and the rear panel USB7 port use the USB78 connector.

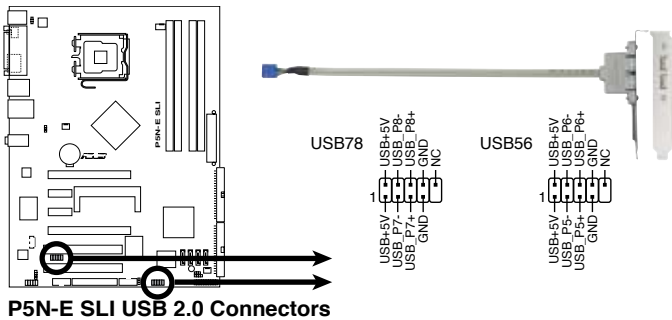

**P5N-E SLI USB 2.0 Connectors**



Never connect a **1394 cable** to the USB connectors. Doing so will damage the motherboard!

## 6. ASUS EZ selector card connector (144-pin SLI\_CON)

This connector is for the ASUS proprietary ASUS EZ selector card that allows you to set the SLI mode to either Single Video card or Dual Video cards.

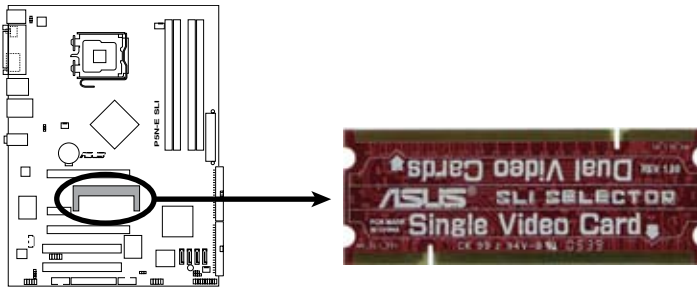

**P5N-E SLI Selector Card Connector**



The EZ Selector card is set to Single Video Card by default.

## 7. Azalia Analog Front Panel (10-1 pin AAFP)

This connector is for a chassis-mounted front panel audio I/O module that supports legacy AC '97 audio standard. Connect one end of the front panel audio I/O module cable to this connector.

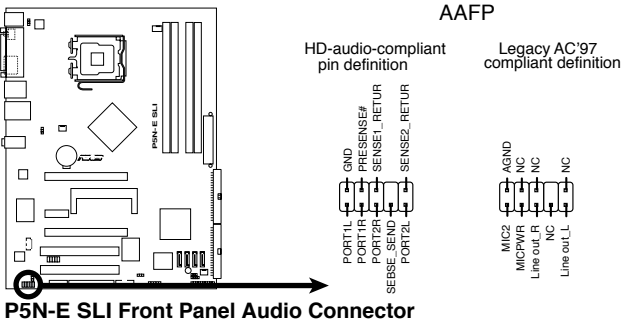

## 8. CPU and Chassis Fan connectors (4-pin CPU\_FAN, 3-pin CHA\_FAN1, 3-pin CHA\_FAN2)

The fan connectors support cooling fans of 350 mA ~ 2000 mA (24 W max.) or a total of 1 A ~ 3.48 A (41.76 W max.) at +12V. Connect the fan cables to the fan connectors on the motherboard, making sure that the black wire of each cable matches the ground pin of the connector.



Do not forget to connect the fan cables to the fan connectors. Insufficient air flow inside the system may damage the motherboard components. These are not jumpers! Do not place jumper caps on the fan connectors!

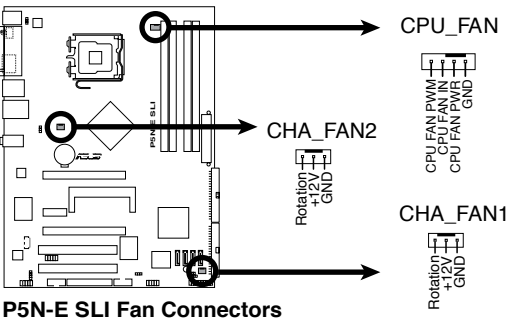

Only the CPU\_FAN connector support the ASUS Q-Fan feature.

## 9. Chassis intrusion connector (4-1 pin CHASSIS)

This connector is for a chassis-mounted intrusion detection sensor or switch. Connect one end of the chassis intrusion sensor or switch cable to this connector. The chassis intrusion sensor or switch sends a high-level signal to this connector when a chassis component is removed or replaced. The signal is then generated as a chassis intrusion event.

By default, the pins labeled “Chassis Signal” and “Ground” are shorted with a jumper cap. Remove the jumper caps only when you intend to use the chassis intrusion detection feature.

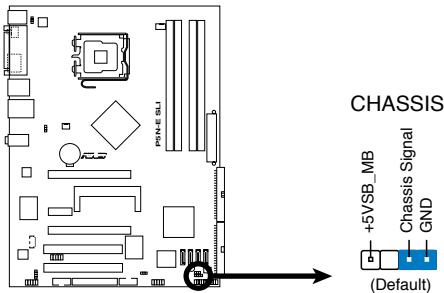

**P5N-E SLI Intrusion Connector**

## 10. ATX power connectors (24-pin EATXPWR, 4-pin EATX12V)

These connectors are for ATX power supply plugs. The power supply plugs are designed to fit these connectors in only one orientation. Find the proper orientation and push down firmly until the connectors completely fit.

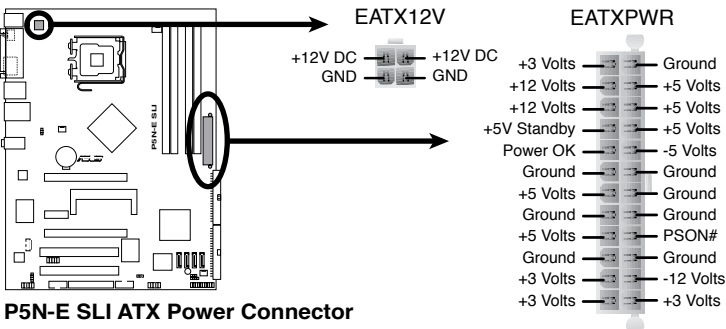

**P5N-E SLI ATX Power Connector**





- For a fully configured system, we recommend that you use a power supply unit (PSU) that complies with ATX 12 V Specification 2.0 (or later version) and provides a minimum power of 400 W.
- Do not forget to connect the 4-pin ATX +12 V power plug; otherwise, the system will not boot.
- Use of a PSU with a higher power output is recommended when configuring a system with more power-consuming devices. The system may become unstable or may not boot up if the power is inadequate.

## Power supply requirements

Components/Peripherals	Heavy	Loading Normal	Light
Intel® LGA775 CPU type	Intel Pentium EE	Intel Pentium D	Intel Pentium 4
PCIe™ x16 graphics cards	6800 Ultra x2	6800GT x2	6600GT x2
DDR DIMMs	4	2	2
HDD	4	2	2
Optical drive (DVD/CD-RW)	2	2	1
PCIe™ x 1 card	1	0	0
PCI cards	2	2	1
USB devices	6	4	3
Required +12V current	> 25A	> 20A	> 17A
Required wattage	>= 500W	>= 400W	>= 350W

### 11. Digital audio connector (4-1 pin SPDIF\_OUT)

This connector is for an additional Sony/Philips Digital Interface (S/PDIF) port(s). Connect the S/PDIF Out module cable to this connector, then install the module to a slot opening at the back of the system chassis.

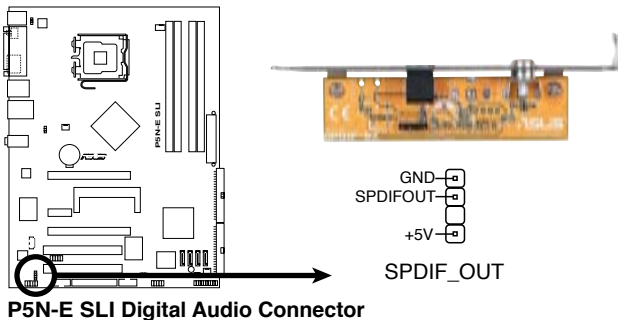

The S/PDIF module is purchased separately.

## 12. System panel connector (20-pin PANEL)

This connector supports several chassis-mounted functions.

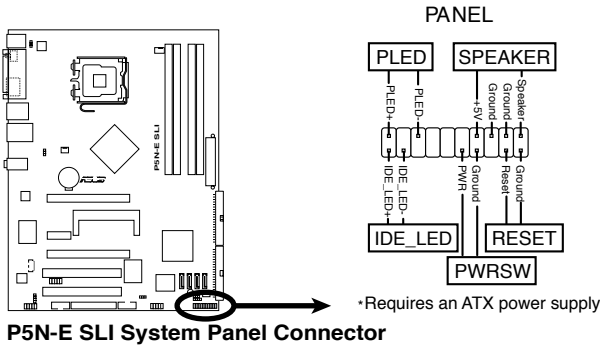

The system panel connector is color-coded for easy connection. Refer to the connector description below for details.

- **System power LED (3-pin PLED)**  
This 3-pin connector is for the system power LED. Connect the chassis power LED cable to this connector. The system power LED lights up when you turn on the system power, and blinks when the system is in sleep mode.
- **Hard disk drive activity LED (2-pin IDE\_LED)**  
This 2-pin connector is for the HDD Activity LED. Connect the HDD Activity LED cable to this connector. The IDE LED lights up or flashes when data is read from or written to the HDD.
- **System warning speaker (4-pin SPEAKER)**  
This 4-pin connector is for the chassis-mounted system warning speaker. The speaker allows you to hear system beeps and warnings.
- **ATX power button/soft-off button (2-pin PWRSW)**  
This connector is for the system power button. Pressing the power button turns the system on or puts the system in sleep or soft-off mode depending on the BIOS settings. Pressing the power switch for more than four seconds while the system is ON turns the system OFF.
- **Reset button (2-pin RESET)**  
This 2-pin connector is for the chassis-mounted reset button for system reboot without turning off the system power.

## Q-Connector (System panel)

ASUS Q-Connector allows you to easily to connect the chassis front panel cables to the motherboard. Perform these steps to install ASUS Q-Connector.

### Step 1

Connect the front panel cables to their respective connectors on the ASUS Q-Connector. Refer to the labels on the Q-Connector for proper connection and pin definition.

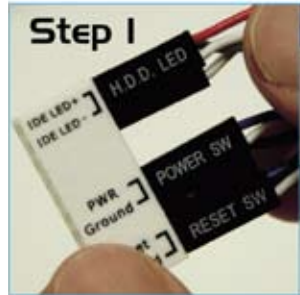

### Step 2

Carefully connect the ASUS Q-Connector to the System panel connector.



The ASUS Q-Connector fits only in one orientation; if it doesn't fit, try reversing it.



When installed, the Q-connector appears as shown.





This chapter tells how to change the system settings through the BIOS Setup menus. Detailed descriptions of the BIOS parameters are also provided.

# BIOS setup **2**

## 2.1 Managing and updating your BIOS

The following utilities allow you to manage and update the motherboard Basic Input/Output System (BIOS) setup.

1. **Award BIOS Flash Utility** (Updates the BIOS in DOS mode using a bootable floppy disk.)
2. **ASUS CrashFree BIOS 2** (Updates the BIOS using a bootable floppy disk or the motherboard support CD when the BIOS file fails or gets corrupted.)
3. **ASUS EZ Flash 2** (Updates the BIOS using a floppy disk, USB Flash, or the motherboard support CD during POST.)
4. **ASUS Update** (Updates the BIOS in Windows® environment.)

Refer to the corresponding sections for details on these utilities.



---

Save a copy of the original motherboard BIOS file to a bootable floppy disk in case you need to restore the BIOS in the future. Copy the original motherboard BIOS using the ASUS Update or AwardBIOS Flash utilities.

---

### 2.1.1 Creating a bootable floppy disk

1. Do either one of the following to create a bootable floppy disk.

#### DOS environment

- a. Insert a 1.44MB floppy disk into the drive.
- b. At the DOS prompt, type `format A: /S` then press <Enter>.

#### Windows® XP environment

- a. Insert a 1.44 MB floppy disk to the floppy disk drive.
- b. Click **Start** from the Windows® desktop, then select **My Computer**.
- c. Select the 3 1/2 Floppy Drive icon.
- d. Click **File** from the menu, then select **Format. A Format 3 1/2 Floppy Disk** window appears.
- e. Select **Create an MS-DOS startup disk** from the format options field, then click Start.

#### Windows® 2000 environment

To create a set of boot disks for Windows® 2000:

- a. Insert a formatted, high density 1.44 MB floppy disk into the drive.
- b. Insert the Windows® 2000 CD to the optical drive.

- c. Click **Start**, then select **Run**.
  - d. From the Open field, type  
`D:\bootdisk\makeboot a:`  
 assuming that D: is your optical drive.
  - e. Press <Enter>, then follow screen instructions to continue.
2. Copy the original or the latest motherboard BIOS file to the bootable floppy disk.

## 2.1.2 Updating the BIOS

The Basic Input/Output System (BIOS) can be updated using the AwardBIOS Flash Utility. Follow these instructions to update the BIOS using this utility.

1. Download the latest BIOS file from the ASUS web site. Rename the file to **P5NESLI.BIN** and save it to a floppy disk.



---

Save only the updated BIOS file in the floppy disk to avoid loading the wrong BIOS file.

---

2. Copy the AwardBIOS Flash Utility (awdfash.exe) from the Software folder of the support CD to the floppy disk with the latest BIOS file.
3. Boot the system in DOS mode using the bootable floppy disk you created earlier.
4. When the **A:>** appears, replace the bootable floppy disk with the floppy disk containing the new BIOS file and the Award BIOS Flash Utility.
5. At the prompt, type **awdfash** then press <Enter>. The Award BIOS Flash Utility screen appears.

```

AwardBIOS Flash Utility for ASUS V1.08
(C) Phoenix Technologies Ltd. All Rights Reserved

For NF-KC804-P5NESLI-00      DATE: 09/25/2005
Flash Type - SST 49LF004A/B /3.3V

File Name to Program: 

Message: Please input File Name!
  
```

6. Type the BIOS file name in the **File Name to Program** field, then press <Enter>.

```
AwardBIOS Flash Utility for ASUS V1.08
(C) Phoenix Technologies Ltd. All Rights Reserved

For NF-KC804-P5NESLI-00      DATE: 03/25/2005
Flash Type - SST 49LF004A/B /3.3V

File Name to Program: P5NESLI.bin

Message: Do You Want To Save Bios (Y/N)
```

7. Press <N> when the utility prompts you to save the current BIOS file. The following screen appears.
8. The utility verifies the BIOS file in the floppy disk and starts flashing the BIOS file.

```
AwardBIOS Flash Utility for ASUS V1.08
(C) Phoenix Technologies Ltd. All Rights Reserved

For NF-KC804-P5NESLI-00      DATE: 03/25/2005
Flash Type - SST 49LF004A/B /3.3V

File Name to Program: P5NESLI.bin

Program Flashing Memory - OFE00 OK

Write OK      No Update      Write Fail

Warning: Don't Turn Off Power Or Reset System!
```



Do not turn off or reset the system during the flashing process!

9. The utility displays a **Flashing Complete** message indicating that you have successfully flashed the BIOS file. Remove the floppy disk then press <F1> to restart the system.

```
AwardBIOS Flash Utility for ASUS V1.08
(C) Phoenix Technologies Ltd. All Rights Reserved

For NF-KC804-P5NESLI-00      DATE: 03/25/2005
Flash Type - SST 49LF004A/B /3.3V

File Name to Program: P5NESLI.bin

Flashing Complete
Press <F1> to Continue

Write OK      No Update      Write Fail

F1 Reset
```



### 2.1.3 Saving the current BIOS file

You can use the AwardBIOS Flash Utility to save the current BIOS file. You can load the current BIOS file when the BIOS file gets corrupted during the flashing process.



Make sure that the floppy disk has enough disk space to save the file.

To save the current BIOS file using the AwardBIOS Flash Utility:

1. Follow steps 1 to 6 of the previous section.
2. Press <Y> when the utility prompts you to save the current BIOS file. The following screen appears.

```
AwardBIOS Flash Utility for ASUS V1.08
(C) Phoenix Technologies Ltd. All Rights Reserved

For C55-MCP51-P5NESLI-00      DATE: 03/25/2005
Flash Type - SST 49LF004A/B /3.3V

File Name to Program: 0111.bin
Save current BIOS as:

Message:
```

3. Type a filename for the current BIOS file in the **Save current BIOS as** field, then press <Enter>.

```
AwardBIOS Flash Utility for ASUS V1.08
(C) Phoenix Technologies Ltd. All Rights Reserved

For NF-KC804-P5NESLI-00      DATE: 03/25/2005
Flash Type - SST 49LF004A/B /3.3V

File Name to Program: 0111.bin
Checksum: DAD6H
Save current BIOS as: old.bin

Message: Please Wait!
```

4. The utility saves the current BIOS file to the floppy disk, then returns to the BIOS flashing process.

```
AwardBIOS Flash Utility for ASUS V1.08
(C) Phoenix Technologies Ltd. All Rights Reserved

For NF-KC804-P5NESLI-00      DATE: 03/25/2005
Flash Type - SST 49LF004A/B /3.3V

File Name to Program: 0111.bin
Now Backup System BIOS to
File!

Message: Please Wait!
```

## 2.1.4 ASUS CrashFree BIOS 2 utility

The ASUS CrashFree BIOS 2 is an auto recovery tool that allows you to restore the BIOS file when it fails or gets corrupted during the updating process. You can update a corrupted BIOS file using the motherboard support CD or the floppy disk that contains the updated BIOS file.



---

Prepare the motherboard support CD or the floppy disk containing the updated motherboard BIOS before using this utility.

---

### Recovering the BIOS from the support CD

To recover the BIOS from the support CD:

1. Turn on the system.
2. Insert the motherboard support CD to the optical drive.
3. The utility displays the following message and automatically checks the CD for the BIOS file.

```
Award BootBlock BIOS v1.0
Copyright (c) 2000, Award Software, Inc.

BIOS ROM checksum error
Detecting IDE ATAPI device...
```

When found, the utility reads the BIOS file and starts flashing the corrupted BIOS file.

```
Award BootBlock BIOS v1.0
Copyright (c) 2000, Award Software, Inc.

BIOS ROM checksum error
Detecting IDE ATAPI device...
Found CDROM, try to Boot from it... Pass
```



---

DO NOT shut down or reset the system while updating the BIOS! Doing so can cause system boot failure!

---

4. Restart the system after the utility completes the updating process.

## Recovering the BIOS from a floppy disk

To recover the BIOS from the floppy disk:

1. Remove any CD from the optical drive, then turn on the system.
2. Insert the floppy disk with the original or updated BIOS file to the floppy disk drive.
3. The utility displays the following message and automatically checks the optical drive for the original or updated BIOS file.

```
Award BootBlock BIOS v1.0
Copyright (c) 2000, Award Software, Inc.

BIOS ROM checksum error
Detecting IDE ATAPI device...
```

When no CD is found, the utility automatically checks the floppy disk for the original or updated BIOS file. The utility then updates the corrupted BIOS file.

```
Award BootBlock BIOS v1.0
Copyright (c) 2000, Award Software, Inc.

BIOS ROM checksum error
Detecting IDE ATAPI device...
  Found CDROM, try to Boot from it.. Fail

Detecting floppy drive A media...
```



---

DO NOT shut down or reset the system while updating the BIOS! Doing so can cause system boot failure!

---

4. Restart the system after the utility completes the updating process.



---

The recovered BIOS may not be the latest BIOS version for this motherboard. Visit the ASUS website ([www.asus.com](http://www.asus.com)) to download the latest BIOS file.

---

## 2.1.5 ASUS EZ Flash 2 utility

The ASUS EZ Flash 2 feature allows you to update the BIOS without having to go through the long process of booting from a floppy disk and using a DOS-based utility. The EZ Flash 2 utility is built-in the BIOS chip so it is accessible by pressing <Alt> + <F2> during the Power-On Self-Test (POST).

To update the BIOS using EZ Flash 2:

1. Visit the ASUS website ([www.asus.com](http://www.asus.com)) to download the latest BIOS file for the motherboard.
2. Save the BIOS file to a floppy disk or a USB flash disk, then restart the system.
3. You can launch the EZ Flash 2 by two methods.
  - (1) Insert the floppy disk / USB flash disk that contains the BIOS file to the floppy disk drive or the USB port.

Press <Alt> + <F2> during POST to display the following.

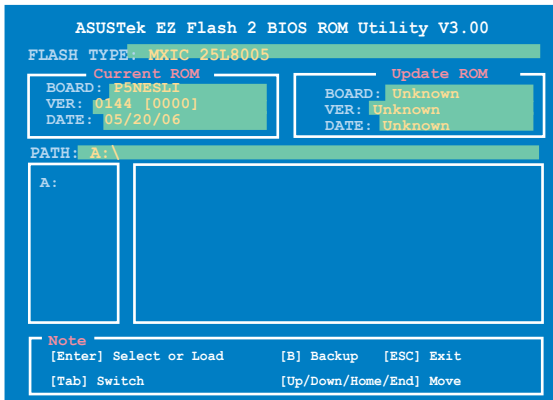

- (2) Enter BIOS setup program. Go to the Tools menu to select EZ Flash2 and press <Enter> to enable it.  
You can switch between drives by pressing <Tab> before the correct file is found. Then press <Enter>.
4. When the correct BIOS file is found, EZ Flash 2 performs the BIOS update process and automatically reboots the system when done.



- This function can support devices such as USB flash disk, or floppy disk with FAT 32/16 format only.
- Do not shut down or reset the system while updating the BIOS to prevent system boot failure!

## 2.1.6 ASUS Update utility

The ASUS Update is a utility that allows you to manage, save, and update the motherboard BIOS in Windows® environment. The ASUS Update utility allows you to:

- Save the current BIOS file
- Download the latest BIOS file from the Internet
- Update the BIOS from an updated BIOS file
- Update the BIOS directly from the Internet, and
- View the BIOS version information.

This utility is available in the support CD that comes with the motherboard package.



---

ASUS Update requires an Internet connection either through a network or an Internet Service Provider (ISP).

---

## Installing ASUS Update

To install ASUS Update:

1. Place the support CD in the optical drive. The Drivers menu appears.
2. Click the Utilities tab, then click Install ASUS Update VX.XX.XX. See page 3-4 for the Utilities screen menu.
3. The ASUS Update utility is copied to your system.



---

Quit all Windows® applications before you update the BIOS using this utility.

---

# Updating the BIOS through the Internet

To update the BIOS through the Internet:

1. Launch the ASUS Update utility from the Windows® desktop by clicking **Start > Programs > ASUS > ASUSUpdate > ASUSUpdate**. The ASUS Update main window appears.

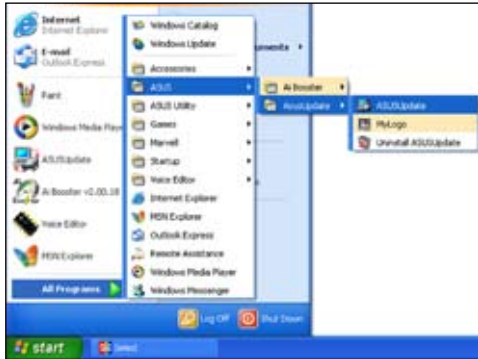

2. Select **Update BIOS from the Internet** option from the drop-down menu, then click Next.



3. Select the ASUS FTP site nearest you to avoid network traffic, or click **Auto Select**. Click **Next**.

- From the FTP site, select the BIOS version that you wish to download. Click Next.
- Follow the screen instructions to complete the update process.



The ASUS Update utility is capable of updating itself through the Internet. Always update the utility to avail all its features.



## Updating the BIOS through a BIOS file

To update the BIOS through a BIOS file:

- Launch the ASUS Update utility from the Windows® desktop by clicking **Start > Programs > ASUS > ASUSUpdate > ASUSUpdate**. The ASUS Update main window appears.
- Select **Update BIOS from a file** option from the drop-down menu, then click **Next**.



- Locate the BIOS file from the **Open** window, then click **Open**.
- Follow the screen instructions to complete the update process.

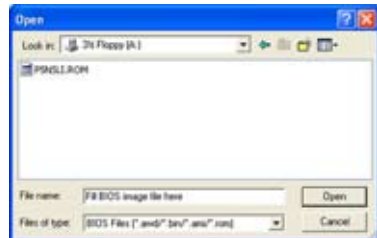

## 2.2 BIOS setup program

This motherboard supports a programmable Low-Pin Count (LPC) chip that you can update using the provided utility described in section “2.1 Managing and updating your BIOS.”

Use the BIOS Setup program when you are installing a motherboard, reconfiguring your system, or prompted to “Run Setup”. This section explains how to configure your system using this utility.

Even if you are not prompted to use the Setup program, you can change the configuration of your computer in the future. For example, you can enable the security password feature or change the power management settings. This requires you to reconfigure your system using the BIOS Setup program so that the computer can recognize these changes and record them in the CMOS RAM of the LPC chip.

The LPC chip on the motherboard stores the Setup utility. When you start up the computer, the system provides you with the opportunity to run this program. Press <Del> during the Power-On Self-Test (POST) to enter the Setup utility; otherwise, POST continues with its test routines.

If you wish to enter Setup after POST, restart the system by pressing <Ctrl>+<Alt>+<Del>, or by pressing the reset button on the system chassis. You can also restart by turning the system off and then back on. Do this last option only if the first two failed.

The Setup program is designed to make it as easy to use as possible. Being a menu-driven program, it lets you scroll through the various sub-menus and make your selections from the available options using the navigation keys.



- 
- The default BIOS settings for this motherboard apply for most conditions to ensure optimum performance. If the system becomes unstable after changing any BIOS settings, load the default settings to ensure system compatibility and stability. Select the Load Default Settings item under the Exit Menu. See section “2.8 Exit Menu.”
  - The BIOS setup screens shown in this section are for reference purposes only, and may not exactly match what you see on your screen.
  - Visit the ASUS website ([www.asus.com](http://www.asus.com)) to download the latest BIOS file for this motherboard.
-



## 2.2.1 BIOS menu screen

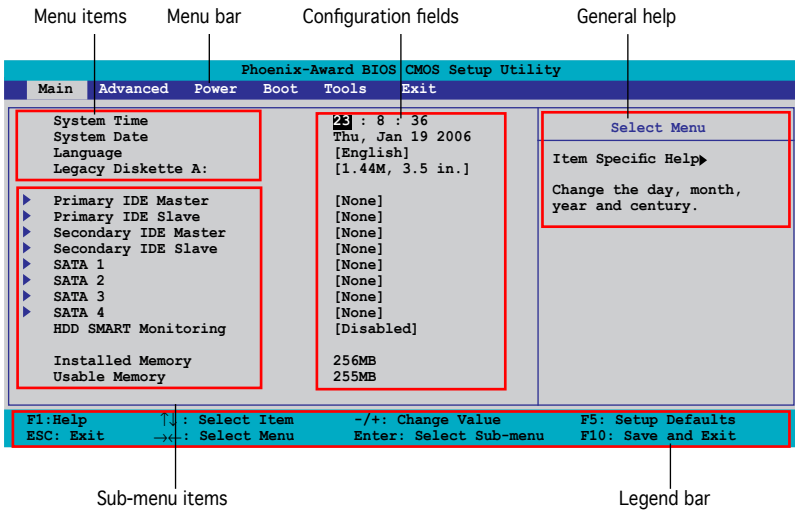

## 2.2.2 Menu bar

The menu bar on top of the screen has the following main items:

- Main** For changing the basic system configuration
- Advanced** For changing the advanced system settings
- Power** For changing the advanced power management (APM) configuration
- Boot** For changing the system boot configuration
- Tools** For using various ASUS BIOS tools.
- Exit** For selecting the exit options and loading default settings

To select an item on the menu bar, press the right or left arrow key on the keyboard until the desired item is highlighted.



- The BIOS setup screens shown in this chapter are for reference purposes only, and may not exactly match what you see on your screen.
- Visit the ASUS website ([www.asus.com](http://www.asus.com)) to download the latest BIOS information.

### 2.2.3 Legend bar

At the bottom of the Setup screen is a legend bar. The keys in the legend bar allow you to navigate through the various setup menus. The following table lists the keys found in the legend bar with their corresponding functions.

Navigation Key	Function
<F1>	Displays the General Help screen
<F5>	Loads setup default values
<Esc>	Exits the BIOS setup or returns to the main menu from a sub-menu
Left or Right arrow	Selects the menu item to the left or right
Up or Down arrow	Moves the highlight up or down between fields
Page Down or - (minus)	Scrolls backward through the values for the highlighted field
Page Up or + (plus)	Scrolls forward through the values for the highlighted field
<Enter>	Brings up a selection menu for the highlighted field
<F10>	Saves changes and exit

### 2.2.4 Menu items

The highlighted item on the menu bar displays the specific items for that menu. For example, selecting Main shows the **Main** menu items.

The other items (Advanced, Power, Boot, and Exit) on the menu bar have their respective menu items.

### 2.2.5 Sub-menu items

A solid triangle before each item on any menu screen means that the item has a sub-menu. To display the sub-menu, select the item and press <Enter>.

### 2.2.6 Configuration fields

These fields show the values for the menu items. If an item is user-configurable, you can change the value of the field opposite the item. You cannot select an item that is not user-configurable.

A configurable field is enclosed in brackets, and is highlighted when selected. To change the value of a field, select it then press <Enter> to display a list of options. Refer to “2.2.7 Pop-up window.”

## 2.2.7 Pop-up window

Select a menu item then press <Enter> to display a pop-up window with the configuration options for that item.

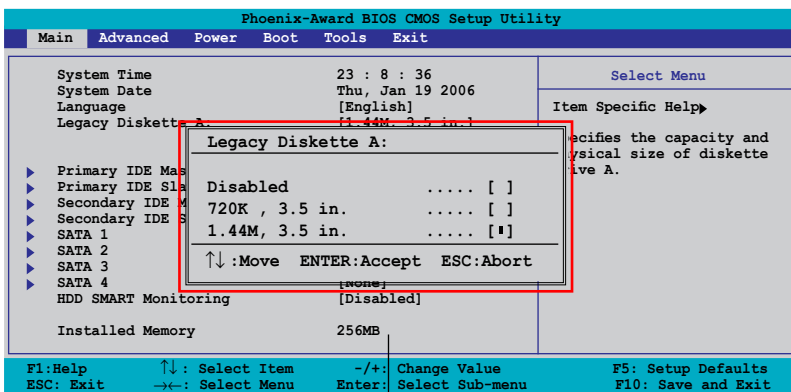

Pop-up menu

## 2.2.8 General help

At the top right corner of the menu screen is a brief description of the selected item.

## 2.3 Main menu

When you enter the BIOS Setup program, the Main menu screen appears, giving you an overview of the basic system information.



Refer to section “2.2.1 BIOS menu screen” for information on the menu screen items and how to navigate through them.

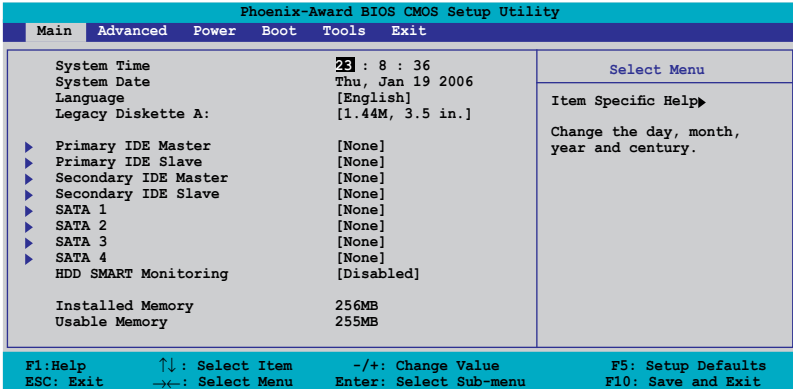

### 2.3.1 System Time [xx:xx:xx]

Allows you to set the system time.

### 2.3.2 System Date [Day xx/xx/xxxx]

Allows you to set the system date.

### 2.3.3 Legacy Diskette A [1.44M, 3.5 in.]

Sets the type of floppy drive installed. Configuration options: [Disabled]  
[720K , 3.5 in.] [1.44M, 3.5 in.]

## 2.3.4 Primary and Secondary IDE Master/Slave

While entering Setup, the BIOS automatically detects the presence of IDE devices. There is a separate sub-menu for each IDE device. Select a device item then press <Enter> to display the IDE device information.

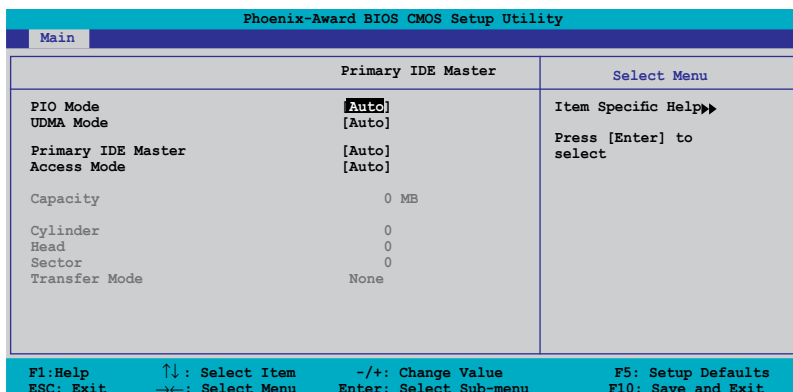

The BIOS automatically detects the values opposite the dimmed items (Capacity, Cylinder, Head, Sector and Transfer Mode). These values are not user-configurable. These items show N/A if no IDE device is installed in the system.

### PIO Mode [Auto]

Sets the PIO mode for the IDE device.

Configuration options: [Auto] [Mode 0] [Mode 1] [Mode 2] [Mode 3] [Mode4]

### UDMA Mode [Auto]

Disables or sets the UDMA mode. Configuration options: [Disable] [Auto]

### Primary IDE Master/Slave [Auto] Secondary IDE Master/Slave [Auto]

Select [Auto] to automatically detect an IDE hard disk drive. If automatic detection is successful, the BIOS automatically fills in the correct values for the remaining fields on this sub-menu. If the hard disk was already formatted on a previous system, the setup BIOS may detect incorrect parameters. Select [Manual] to manually enter the IDE hard disk drive parameters. If no drive is installed select [None].

Configuration options: [None] [Auto] [Manual]

## Access Mode [Auto]

The default [Auto] allows automatic detection of an IDE hard disk drive. Select [CHS] for this item if you set the IDE Primary Master/Slave to [Manual]. Configuration options: [CHS] [LBA] [Large] [Auto]



---

Before attempting to configure a hard disk drive, make sure you have the correct configuration information supplied by the drive manufacturer. Incorrect settings may cause the system to fail to recognize the installed hard disk.

---

## Capacity

Displays the auto-detected hard disk capacity. This item is not configurable.

## Cylinder

Shows the number of the hard disk cylinders. This item is not configurable.

## Head

Shows the number of the hard disk read/write heads. This item is not configurable.

## Sector

Shows the number of sectors per track. This item is not configurable.

## Transfer Mode

Shows the Transfer mode. This item is not configurable.



---

After entering the IDE hard disk drive information into BIOS, use a disk utility, such as FDISK, to partition and format new IDE hard disk drives. This is necessary so that you can write or read data from the hard disk. Make sure to set the partition of the Primary IDE hard disk drives to active.

---

## 2.3.5 SATA1, SATA2, SATA3, SATA4

While entering Setup, the BIOS automatically detects the presence of Serial ATA devices. There is a separate sub-menu for each SATA device. Select a device item then press <Enter> to display the SATA device information.

Phoenix-Award BIOS CMOS Setup Utility		
Main		
	Primary IDE Master	Select Menu
Extended IDE Drive Access Mode	[Auto] [Auto]	Item Specific Help▶▶ Press [Enter] to select
Capacity	xxxxxx MB	
Cylinder	xxxxxx	
Head	xx	
Landing Zone	xx	
Sector	xx	

F1: Help      ↑↓: Select Item      -/+ : Change Value      F5: Setup Defaults  
ESC: Exit    →←: Select Menu      Enter: Select Sub-menu      F10: Save and Exit

The BIOS automatically detects the values opposite the dimmed items (Capacity, Cylinder, Head, Precomp, Landing Zone and Sector). These values are not user-configurable. These items show 0 if no SATA device is installed in the system.

### Extended IDE Drive [Auto]

Selects the type of fixed disk connected to the system.  
Configuration options: [None] [Auto]

### Access Mode [Auto]

Sets the sector addressing mode. Configuration options: [Large] [Auto]



Before attempting to configure a hard disk drive, make sure you have the correct configuration information supplied by the drive manufacturer. Incorrect settings may cause the system to fail to recognize the installed hard disk.

### Capacity

Displays the auto-detected hard disk capacity. This item is not configurable.

### Cylinder

Shows the number of the hard disk cylinders. This item is not configurable.

### Head

Shows the number of the hard disk read/write heads. This item is not configurable.

## Landing Zone

Shows the number of landing zone per track. This item is not configurable.

## Sector

Shows the number of sectors per track. This item is not configurable.



---

After entering the IDE hard disk drive information into BIOS, use a disk utility, such as FDISK, to partition and format new IDE hard disk drives. This is necessary so that you can write or read data from the hard disk. Make sure to set the partition of the Primary IDE hard disk drives to active.

---

### 2.3.6 HDD SMART Monitoring [Disabled]

Allows you to enable or disable the HDD Self-Monitoring Analysis and Reporting Technology (SMART) feature.

Configuration options: [Disabled] [Enabled]

### 2.3.7 Installed Memory

Shows the size of installed memory.

### 2.3.8 Usable Memory

Shows the size of usable memory.



## 2.4 Advanced menu

The Advanced menu items allow you to change the settings for the CPU and other system devices.



Take caution when changing the settings of the Advanced menu items. Incorrect field values can cause the system to malfunction.

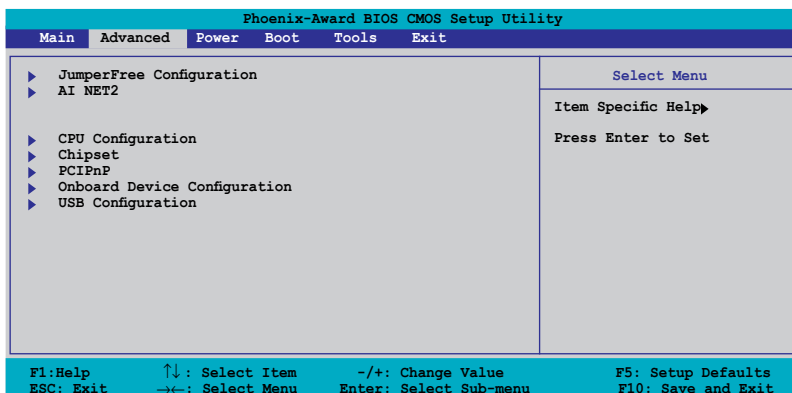

### 2.4.1 JumperFree Configuration

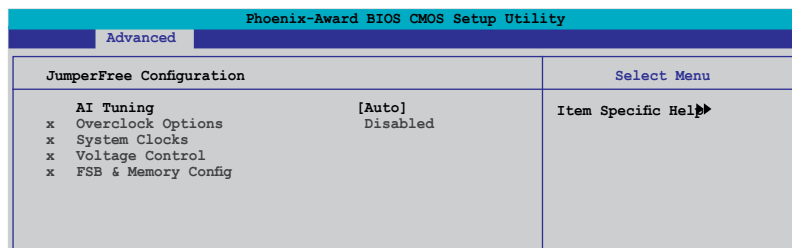

#### AI Tuning [Auto]

Allows selection of CPU overclocking options to achieve desired CPU internal frequency. Select either one of the preset overclocking configuration options:

Manual                      Allows you to individually set overclocking parameters.

Auto                              Loads the optimal settings for the system.

Standard                      Loads the standard settings for the system.

AI Overclock                Loads overclocking profiles with optimal parameters for stability when overclocking.

## Overclock Options [Disabled]

Allows you to disable or set the overclocking options.

Configuration options: [Disabled] [Overclock 5%] [Overclock 10%]  
[Overclock 15%] [Overclock 20%]



The Overclock Options item is user-configurable only when the AI Tuning is set to [AI Overclock].

## System Clocks

This sub-menu allows you to set PCI Express related field. Set the AI Tuning to [Manual], if you want to configure this item.

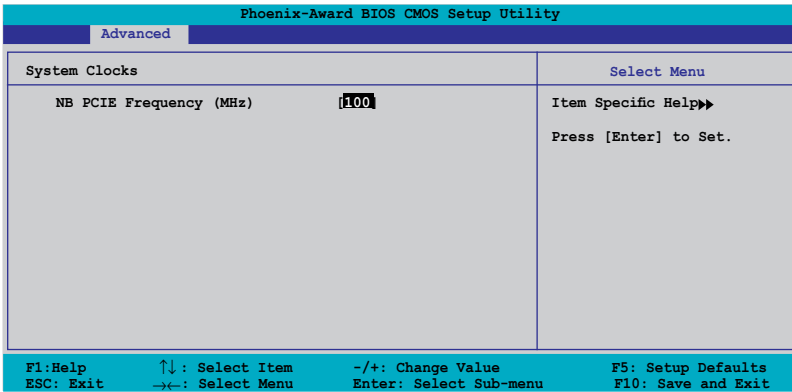

### NB PCIE Frequency [100]

Allows you to set the PCI Express frequency. Key-in a decimal value between 100-131 MHz. Configuration options: [100MHz] [101MHz] ~ [130MHz] [131MHz]



Selecting a very high PCIE frequency may cause the system to become unstable! If this happens, revert to the default setting.

## Voltage Control

This sub-menu allows you to set the system operating voltages. Set the AI Tuning to [Manual], if you want to configure this item.

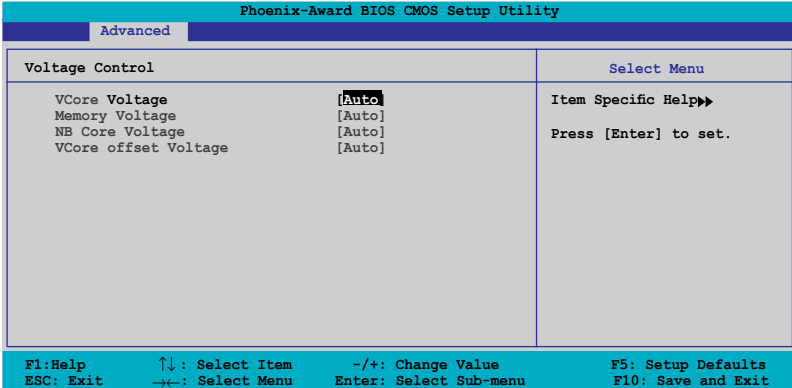

### VCore Voltage [Auto]

Sets the operating VCore voltage. Configuration options: [Auto]  
 [1.60000V] [1.59375V] [1.58750V] [1.58125V] [1.57500V]  
 [1.56875V] [1.56250V] [1.55625V] [1.55000V] [1.54375V]  
 [1.53750V] [1.53125V] [1.52500V] [1.51875V] [1.51250V]  
 [1.50625V] [1.50000V] [1.49375V] [1.48750V] [1.48125V]  
 [1.47500V] [1.46875V] [1.46250V] [1.45625V] [1.45000V]  
 [1.44375V] [1.43750V] [1.43125V] [1.42500V] [1.41875V]  
 [1.41250V] [1.40625V] [1.40000V] [1.39375V] [1.38750V]  
 [1.38125V] [1.37500V] [1.36875V] [1.36250V] [1.35625V]  
 [1.35000V] [1.34375V] [1.33750V] [1.33125V] [1.32500V]  
 [1.31875V] [1.31250V] [1.30625V] [1.30000V] [1.29375V]  
 [1.28750V] [1.28125V] [1.27500V] [1.26875V] [1.26250V]  
 [1.25625V] [1.25000V] [1.24375V] [1.23750V] [1.23125V]  
 [1.22500V] [1.21875V] [1.21250V] [1.20625V] [1.20000V]  
 [1.19375V] [1.18750V] [1.18125V] [1.17500V] [1.16875V]  
 [1.16250V] [1.15625V] [1.15000V] [1.14375V] [1.13750V]  
 [1.13125V] [1.12500V] [1.11875V] [1.11250V] [1.10625V]  
 [1.10000V] [1.09375V] [1.08750V] [1.08125V] [1.07500V]  
 [1.06875V] [1.06250V] [1.05625V] [1.05000V] [1.04375V]  
 [1.03750V] [1.03125V] [1.02500V] [1.01875V] [1.01250V]  
 [1.00625V] [1.00000V] [0.99375V] [0.98750V] [0.98125V]  
 [0.97500V] [0.96875V] [0.96250V] [0.95625V] [0.95000V]  
 [0.94375V] [0.93750V] [0.93125V] [0.92500V] [0.91875V]  
 [0.91250V] [0.90625V] [0.90000V] [0.89375V] [0.88750V]  
 [0.88125V] [0.87500V] [0.86875V] [0.86250V] [0.85625V]  
 [0.85000V] [0.84375V] [0.83750V] [0.83125V]

### Memory Voltage [Auto]

Allows you to set the memory operating voltage. Set to Auto for safe mode. Configuration options: [Auto] [1.920V] [2.013V] [2.085V] [2.178V] [2.259V] [2.353V] [2.424V] [2.517V]



Refer to the DDR2 documentation before setting the memory voltage. Setting a very high memory voltage may damage the memory module(s)!

### NB Core Voltage [Auto]

Allows you to set the NB core voltage. Configuration options: [Auto] [1.208V] [1.393V] [1.563V] [1.748V]

### VCore offset Voltage [Auto]

Allows you to set the VCore offset voltage. Configuration options: [Auto] [+100mv]

## FSB & Memory Config

This sub-menu allows you to set FSB & Memory config. Set the AI Tuning to [Manual], if you want to configure this item.

Phoenix-Award BIOS CMOS Setup Utility		
Advanced		
FSB & Memory Config		Select Menu
FSB - Memory Clock Mode	[Linked]	Item Specific Help▶▶
FSB - Memory Ratio	[Auto]	Press [Enter] to Set.
FSB (QDR), MHz	[800]	
Actual FSB (QDR), MHz	800.0	
x MEM (DDR), MHz	Linked	
Actual MEM (DDR), MHz	533.3	

F1: Help      ↑↓: Select Item      -/+ : Change Value      F5: Setup Defaults  
ESC: Exit      ←: Select Menu      Enter: Select Sub-menu      F10: Save and Exit

### FSB - Memory Clock Mode [Auto]

Allows you to set the FSB - Memory Clock Mode. Configuration options: [Auto] [Linked] [Unlinked]

### FSB - Memory Ratio [Auto]

Allows you to set the FSB - Memory Ratio. Configuration options:  
[Auto] [1:1] [5:4] [3:2] [Sync Mode]

### FSB (QDR), MHz [800]

Allows you to set the FSB (QDR), MHz. Configuration options:  
[Min= 533] [Max= 3000]

### MEM (DDR), MHz [Unlinked]

Allows you to set the MEM (DDR), MHz.  
Configuration options: [Unlinked] [Linked]

## 2.4.2 AI NET2

The items in this menu displays the status of the Local Area Network (LAN) cable.

Phoenix-Award BIOS CMOS Setup Utility			
Advanced			
AI NET2			Select Menu
POST Check LAN Cable	<b>[Disabled]</b>		Item Specific Help▶▶
Pair	Status	Length	Check LAN cable during POST.
LAN1 (1-2)	Open	N/A	
LAN1 (3-6)	Open	N/A	
LAN1 (4-5)	Open	N/A	
LAN1 (7-8)	Open	N/A	
F1: Help      ↑↓ : Select Item      -/+ : Change Value      F5: Setup Defaults			
ESC: Exit      →← : Select Menu      Enter: Select Sub-menu      F10: Save and Exit			

### **POST Check LAN Cable [Disabled]**

Enables or disables LAN cable check during POST.  
Configuration options: [Disabled] [Enabled]

## 2.4.3 CPU Configuration

Phoenix-Award BIOS CMOS Setup Utility		
Advanced		
CPU Configuration		Select Menu
CPU Type	Genuine Intel(R) CPU	Item Specific Help▶▶
CPU Speed	2.80GHz	
Cache RAM	2048K	
CPU Multiplier	<b>[14]</b>	DRAM timing and control
CPU Core Unlock	[Disabled]	
CPU Internal Thermal Control	[Auto]	
Limit CPUID MaxVal	[Disabled]	
Enhanced C1 (C1E)	[Disabled]	
Execute Disable Bit	[Enabled]	
Enhanced Intel SpeedStep (tm) Tech.	[Disabled]	
Hyper-Threading Technology	[Enabled]	

F1: Help    ↑↓: Select Item    -/+ : Change Value    F5: Setup Defaults  
ESC: Exit    →←: Select Menu    Enter: Select Sub-menu    F10: Save and Exit

### CPU Multiplier [14]

Allows you to adjust the CPU Multiplier from 6 to 50.  
Configuration options: [6] [7] [8] [9] ... [49] [50]

### CPU Core Unlock [Disabled]

Enables or disables the CPU Core Unlock.  
Configuration options: [Disabled] [Enabled]

### CPU Internal Thermal Control [Auto]

Enables or disables the CPU Internal Thermal Control feature.  
Configurable options: [Auto] [Disabled]

### Limit CPUID MaxVal [Disabled]

Enables or disables the CPU ID maximum value limit.  
Configuration options: [Disabled] [Enabled]

### Enhanced C1 (C1E) [Disabled]

When set to [Auto], the BIOS automatically check the CPU's capability to enable the C1E support. In C1E mode, the CPU power consumption is lower when idle. This item appears only when you install a processor with Enhanced C1E feature.  
Configuration options: [Enabled] [Disabled]

### Execute Disable Bit [Enabled]

When disabled, the processor forces the XD feature flag to always return 0. Configuration options: [Disabled] [Enabled]

### Enhanced Intel SpeedStep(tm) Tech. [Disabled]

Allows you to use the Enhanced Intel SpeedStep® Technology. When set to [Auto], you can adjust the system power settings in the operation system to use the EIST feature. Set this item to [Disabled] if you do not want to use the EIST.

Configuration options: [Disabled] [Enabled]

### Hyper-Threading Technology [Enabled]

Enables or disables the Intel® Hyper-Threading Technology feature. This item appears only when you install a Hyper-Treading CPU.

Configuration options: [Disabled] [Enabled]

## 2.4.4 Chipset

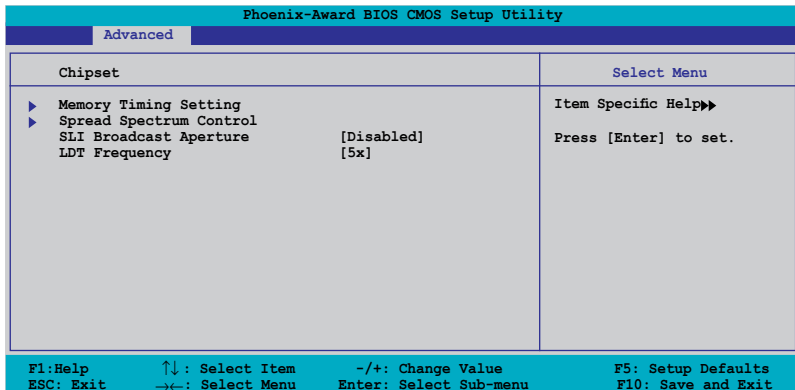

# Memory Timing Setting

Phoenix-Award BIOS CMOS Setup Utility			
Advanced			
Memory Timing Setting		Select Menu	
tCL (CAS Latency)	[Auto]	Item Specific Help▶▶	
tRCD	[Auto]		
tRP	[Auto]	Select [Expert] to enter timings manually	
tRAS	[Auto]		
Command Per Clock (CMD)	[Auto]		
** Advanced Memory Settings **			
tRRD	[Auto]		
tRC	[Auto]		
tWR	[Auto]		
tWTR	[Auto]		
tREF	[Auto]		
tRD	[7]		
tRFC	[114]		
Async Latency	[Auto]		
F1: Help	↑↓: Select Item	-/+ : Change Value	F5: Setup Defaults
ESC: Exit	→←: Select Menu	Enter: Select Sub-menu	F10: Save and Exit

## tCL (CAS Latency) [Auto]

Sets the CAS latency timing.

Configuration options: [Auto] [1] [2] [3] [4] [5] [6]

## tRCD [Auto]

Sets the RAS-to-CAS delay timing.

Configuration options: [Auto] [1] [2] [3] [4] [5] [6] [7]

## tRP [Auto]

Sets the row-precharge delay timing.

Configuration options: [Auto] [1] [2] [3] [4] [5] [6] [7]

## tRAS [Auto]

Sets the row-active delay timing.

Configuration options: [Auto] [1] [2] ~ [31]

## Command Per Clock [Auto]

Sets the command timing. (per clock unit)

Configuration options: [Auto] [1 clock] [2 clock]

## tRRD [Auto]

Sets the RAS-to-RAS delay timing.

Configuration options: [Auto] [1] [2] ~ [15]



### tRC [Auto]

Sets the row cycle timing.

Configuration options: [Auto] [1] [2] ~ [31]

### tWR [Auto]

Sets the WR delay timing.

Configuration options: [Auto] [1] [2] [3] [4] [5] [6] [7]

### tWTR [Auto]

Sets the WTR delay timing.

Configuration options: [Auto] [1] [2] ~ [15]

### tREF [Auto]

Sets the REF delay timing.

Configuration options: [Auto] [1] [2]

### tRD [7]

Sets the RD delay timing.

Configuration options: [Auto] [1] [2] ~ [15]

### tRFC [114]

Sets the RFC delay timing.

Configuration options: [Auto] [1] [2] ~ [127]

### Async Latency [Auto]

Sets the Async latency timing.

Configuration options: [Auto] [1.00nS] [1.25nS] [1.50nS] [1.75nS]  
[2.00nS] [2.25nS] [2.50nS]

## Spread Spectrum Control

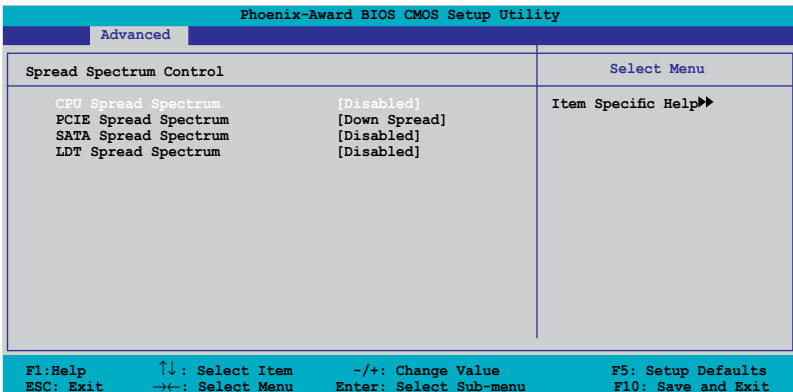

*CPU Spread Spectrum [Disabled]*

Enables or disables CPU Spread Spectrum.  
Configuration options: [Disabled] [Auto]

*PCIe Spread Spectrum [Down Spread]*

Enables or disables PCIe Spread Spectrum.  
Configuration options: [Disabled] [Down Spread]

*SATA Spread Spectrum [Disabled]*

Enables or disables SATA Spread Spectrum.  
Configuration options: [Disabled] [Auto]

*LDT Spread Spectrum [Disabled]*

Enables or disables LDT Spread Spectrum.  
Configuration options: [Disabled] [Center] [Down]

**SLI Broadcast Aperture [Disabled]**

Enables or disables the SLI Broadcast Aperture.  
Configuration options: [Auto] [Disabled]

**LDT Frequency [5x]**

Sets the Lightning Data Transport (LDT) frequency multiplier.  
Configuration options: [1x] [2x] [3x] [4x] [5x] [6x] [7x] [8x]

## 2.4.5 PCIPnP

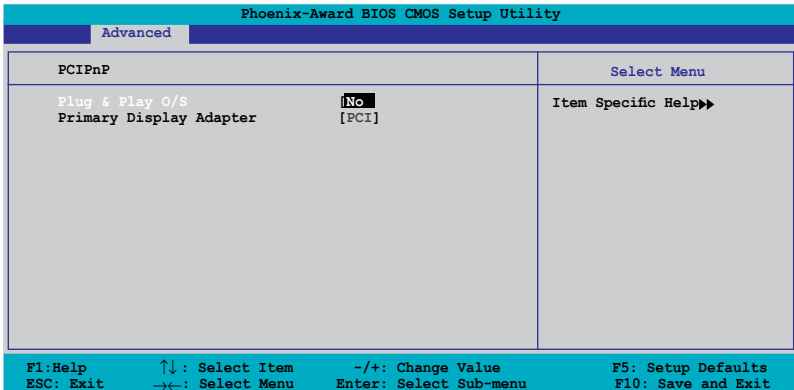

### Plug & Play O/S [No]

Selects the plug and play O/S to operate system.  
Configuration options: [No] [Yes]

### Primary Display Adapter [PCI]

Allows you to set which graphics controller to use as primary boot device.  
Configuration options: [PCI] [PCI-E]

## 2.4.6 Onboard Devices Configuration

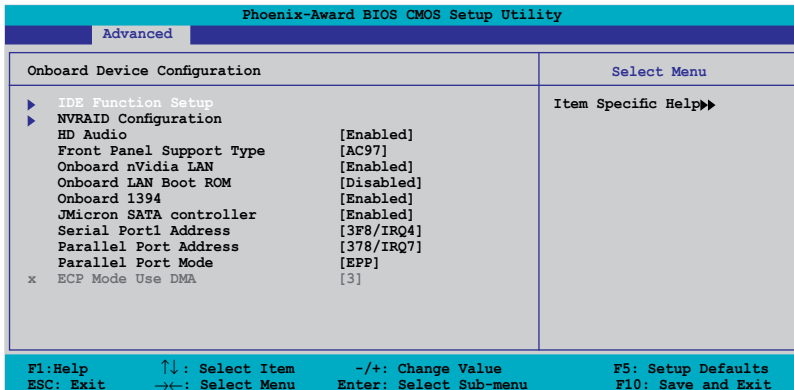

## IDE Function Setup

This sub-menu contains IDE function-related items. Select an item then press <Enter> to edit.

Phoenix-Award BIOS CMOS Setup Utility		
Advanced		
IDE Function Setup		Select Menu
OnChip IDE Channel0	[Enabled]	Item Specific Help▶▶
OnChip IDE Channel1	[Enabled]	
IDE DMA transfer access	[Enabled]	Disable/Enable OnChip
SATA Port 1, 2	[Enabled]	IDE Channel0
SATA DMA transfer	[Enabled]	
SATA Port 3, 4	[Enabled]	
SATA2 DMA transfer	[Enabled]	
IDE Prefetch Mode	[Enabled]	

F1: Help      ↑↓: Select Item      -/+ : Change Value      F5: Setup Defaults  
ESC: Exit      →←: Select Menu      Enter: Select Sub-menu      F10: Save and Exit

### OnChip IDE Channel0 [Enabled]

Allows you to enable or disable the onchip IDE channel 0 controller .  
Configuration options: [Disabled] [Enabled]

### OnChip IDE Channel1 [Enabled]

Allows you to enable or disable the onchip IDE channel 1 controller .  
Configuration options: [Disabled] [Enabled]

### IDE DMA transfer access [Enabled]

Allows you to enable or disable the IDE DMA transfer access.  
Configuration options: [Disabled] [Enabled]

### SATA Port 1, 2 [Enabled]

Allows you to enable or disable the SATA 1 and 2 ports.  
Configuration options: [Enabled] [Disabled]

### SATA DMA transfer [Enabled]

Allows you to enable or disable the SATA DMA transfer access.  
Configuration options: [Enabled] [Disabled]

### SATA Port 3, 4 [Enabled]

Allows you to enable or disable the SATA 3 and 4 ports.  
Configuration options: [Enabled] [Disabled]

### SATA2 DMA transfer [Enabled]

Allows you to enable or disable the SATA2 DMA transfer access.  
Configuration options: [Enabled] [Disabled]

### IDE Prefetch Mode [Enabled]

Allows you to enable or disable the IDE prefetch mode.  
Configuration options: [Disabled] [Enabled]

## NVRAID Configuration

This sub-menu contains NVRAID function-related items. Select an item then press <Enter> to edit.

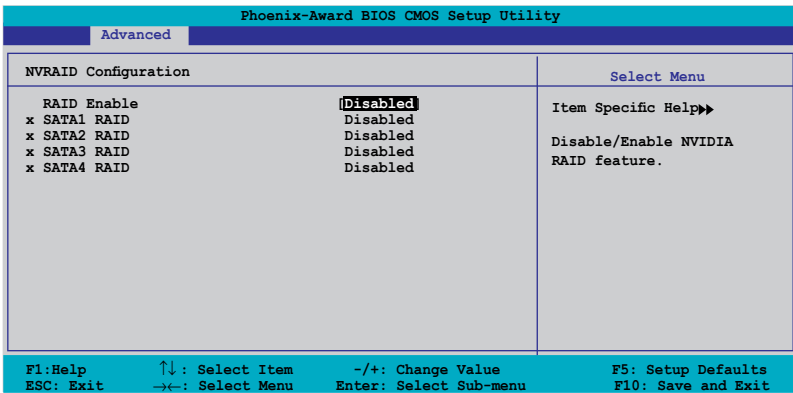

### RAID Enable [Disabled]

Enables or disables the onboard RAID controller. When set to [Enabled], the succeeding items becomes user-configurable.  
Configuration options: [Disabled] [Enabled]

### SATA1, SATA2, SATA3, SATA4 RAID [Disabled]

Enables or disables the RAID function of the SATA1, SATA2, SATA3 or SATA4 master drive. Configuration options: [Disabled] [Enabled]

## HD Audio [Enabled]

Allows you to disable or enabled the onboard HD audio controller.  
Configuration options: [Disabled] [Enabled]

## Front Panel Support Type [AC97]

Allows you to select the Front Panel Type AC97 or HD Audio.  
Configuration options: [AC97] [HD Audio]

### **Onboard nVidia LAN [Enabled]**

Enables or disables the onboard NVIDIA® Gigabit LAN controller.  
Configuration options: [Disabled] [Enabled]

### **OnBoard LAN Boot ROM [Disabled]**

Allows you to enable or disable the onboard NVIDIA® LAN boot ROM.  
Configuration options: [Enabled] [Disabled]

### **Onboard 1394 [Enabled]**

Enables or disables the onboard 1394 device support.  
Configuration options: [Disabled] [Enabled]

### **JMicron SATA controller [Enabled]**

Enables or disables the JMiron SATA controller.  
Configuration options: [Disabled] [Enabled]

### **Serial Port1 Address [3F8/IRQ4]**

Allows you to select the Serial Port1 base address.  
Configuration options: [Disabled] [3F8/IRQ4] [2F8/IRQ3] [3E8/IRQ4]  
[2E8/IRQ3] [Auto]

### **Parallel Port Address [378/IRQ7]**

Allows you to select the Parallel Port base addresses.  
Configuration options: [Disabled] [378/IRQ7] [278/IRQ5] [3BC/IRQ7]

### **Parallel Port Mode [EPP]**

Allows you to select the Parallel Port mode.  
Configuration options: [Normal] [EPP] [ECP] [Bi-Directional]



---

The following item appears only when the Parallel Port Mode is set to [ECP].

---

#### ***ECP Mode Use DMA [3]***

Allows selection of ECP Mode. Configuration options: [1] [3]

## 2.4.7 USB Configuration

The items in this menu allows you to change the USB-related features. Select an item then press <Enter> to display the configuration options.

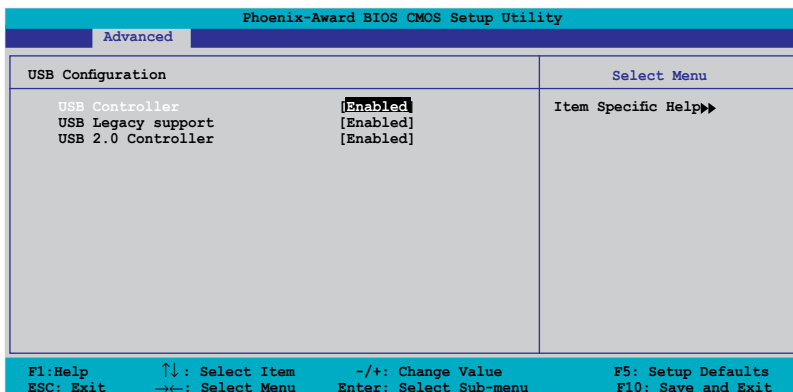

### USB Controller [Enabled]

Allows you to enable or disable the onchip USB controller.  
Configuration options: [Disabled] [Enabled]

### USB Legacy Support [Enabled]

Allows you to enable or disable support for USB devices on legacy operating systems (OS). Configuration options: [Disabled] [Enabled]

### USB 2.0 Controller [Enabled]

Allows you to enable or disable the USB 2.0 controller.  
Configuration options: [Disabled] [Enabled]

## 2.5 Power menu

The Power menu items allow you to change the settings for the Advanced Configuration and Power Interface (ACPI) and the Advanced Power Management (APM). Select an item then press <Enter> to display the configuration options.

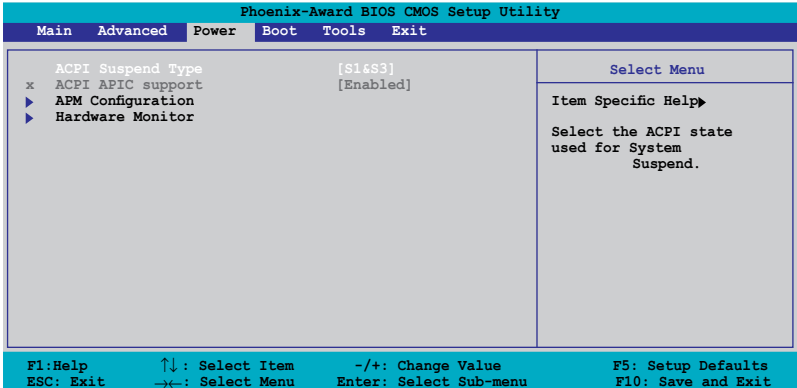

### 2.5.1 ACPI Suspend Type [S1&S3]

Allows you to select the Advanced Configuration and Power Interface (ACPI) state to be used for system suspend.

Configuration options: [S1(POS)] [S3(STR)] [S1&S3]

### 2.5.2 ACPI APIC Support Enabled

Allows you to enable or disable the Advanced Configuration and Power Interface (ACPI) support in the Application-Specific Integrated Circuit (ASIC).



## 2.5.3 APM Configuration

Phoenix-Award BIOS CMOS Setup Utility		
Power		
APM Configuration		Select Menu
Restore on AC Power Loss	[Power-Off]	Item Specific Help▶▶
PWR Button < 4 secs	[Instant-Off]	
Power Up On PCI/PCIE Devices	[Disabled]	
Power On By External Modems	[Disabled]	
Power On By RTC Alarm	[Disabled]	
x Date (of Month) Alarm	0	
x Alarm (hh:mm:ss) Time	0 : 0 : 0	
HPET Support	[Enabled]	
Power Up By PS/2 Mouse	[Disabled]	
Power Up By PS/2 Keyboard	[Disabled]	
F1: Help      ↑↓ : Select Item      -/+ : Change Value      F5: Setup Defaults ESC: Exit    →← : Select Menu      Enter: Select Sub-menu      F10: Save and Exit		

### Restore on AC Power Loss [Power-Off]

Allows you to enable or disable the Restore on AC Power Loss function. Configuration options: [Power-Off] [Power-On] [Last State]

### PWR Button < 4 secs [Instant-Off]

Allows you to set the event after the power button is pressed for more than 4 seconds. Configuration options: [Suspend] [Instant-Off]

### Power Up On PCI/PCIE Devices [Disabled]

When set to [Enabled], this parameter allows you to turn on the system through a PCI LAN or modem card. This feature requires an ATX power supply that provides at least 1A on the +5VSB lead.

Configuration options: [Disabled] [Enabled]

### Power On By External Modems [Disabled]

This allows either settings of [Enabled] or [Disabled] for powering up the computer when the external modem receives a call while the computer is in Soft-off mode. Configuration options: [Disabled] [Enabled]



The computer cannot receive or transmit data until the computer and applications are fully running. Thus, connection cannot be made on the first try. Turning an external modem off and then back on while the computer is off causes an initialization string that turns the system power on.

## **Power On By RTC Alarm [Disabled]**

Allows you to enable or disable RTC to generate a wake event. When this item is set to Enabled, the items Date of Month Alarm and Time (hh:mm:ss) Alarm items become user-configurable with set values.

Configuration options: [Disabled] [Enabled]

## **Date (of Month) Alarm [Disabled]**

To set the date of alarm, highlight this item and press <Enter> to display the Day of Month Alarm pop-up menu. Key-in a value within the specified range then press <Enter>. Configuration options: [Min=0] [Max=31]

## **Alarm (hh:mm:ss) Time [Disabled]**

To set the time of alarm:

1. Highlight this item and press <Enter> to display a pop-up menu for the hour field.
2. Key-in a value (Min=0, Max=23), then press <Enter>.
3. Press <TAB> to move to the minutes field then press <Enter>.
4. Key-in a minute value (Min=0, Max=59), then press <Enter>.
5. Press <TAB> to move to the seconds field then press <Enter>.
6. Key-in a value (Min=0, Max=59), then press <Enter>.

## **HPET Support [Enabled]**

Allows you to enable or disable the HPET Support.

Configuration options: [Disabled] [Enabled]

## **Power Up By PS/2 Mouse [Disabled]**

When set to [Enabled], this parameter allows you to use the PS/2 mouse to turn on the system. This feature requires an ATX power supply that provides at least 1A on the +5VSB lead.

Configuration options: [Disabled] [Enabled]

## **Power Up By PS/2 Keyboard [Disabled]**

Allows you to disable the Power On by PS/2 keyboard function or set specific keys on the PS/2 keyboard to turn on the system. This feature requires an ATX power supply that provides at least 1A on the +5VSB lead.

Configuration options: [Disabled] [Space Bar] [Ctrl-ESC] [Power Key]

## 2.5.4 Hardware Monitor

The items in this sub-menu displays the hardware monitor values automatically detected by the BIOS. It also allows you to change CPU Q-Fan feature-related parameters. Select an item then press <Enter> to display the configuration options.

Phoenix-Award BIOS CMOS Setup Utility			
Power			
Hardware Monitor		Select Menu	
CPU Q-Fan Control	[Disabled]	Item Specific Help▶▶  Press [Enter] to enable or disable	
Chassis Q-Fan Control	[Disabled]		
Vcore Voltage	[1.32V]		
3.3V Voltage	[3.28V]		
5V Voltage	[4.94V]		
12V Voltage	[11.84V]		
CPU Temperature	66°C		
M/B Temperature	38°C		
CPU FAN Speed	4470 RPM		
CHA_FAN1 Speed	0 RPM		
CHA_FAN2 Speed	0 RPM		
CPU Fan Speed warning	[600 RPM]		
F1: Help	↑↓ : Select Item	-/+ : Change Value	F5: Setup Defaults
ESC: Exit	→← : Select Menu	Enter: Select Sub-menu	F10: Save and Exit

### CPU Q-Fan Control [Disabled]

Allows you to enable or disable the ASUS Q-Fan feature.

Configuration options: [Disabled] [Enabled]

### Chassis Q-Fan Controller [Disabled]

Allows you to enable or disable the ASUS Chassis Q-Fan feature.

Configuration options: [Disabled] [Enabled]

### VCORE Voltage, +3.3V Voltage, 5V Voltage, 12V Voltage

The onboard hardware monitor automatically detects the voltage output through the onboard voltage regulators. These items can be set to [Ignored].

### CPU Temperature, M/B Temperature

The onboard hardware monitor automatically detects and displays the motherboard and CPU temperatures. These items are not user-configurable.

### CPU Fan Speed, CHA\_FAN1 Speed, CHA\_FAN2 Speed

The onboard hardware monitor automatically detects and displays the CPU, Power, and Chassis fan speeds in rotations per minute (RPM). If the fan is not connected to the motherboard, the field shows 0. These items are not user-configurable.

### CPU Fan Speed Warning [600 RPM]

Allows you to set the CPU fan warning speed.

Configuration options: [Disabled] [600 RPM] [1200 RPM] [1600 RPM]

## 2.6 Boot menu

The Boot menu items allow you to change the system boot options. Select an item then press <Enter> to display the sub-menu.

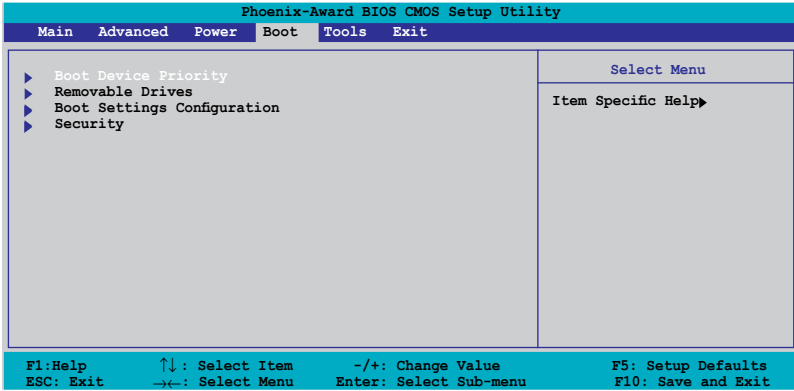

### 2.6.1 Boot Device Priority

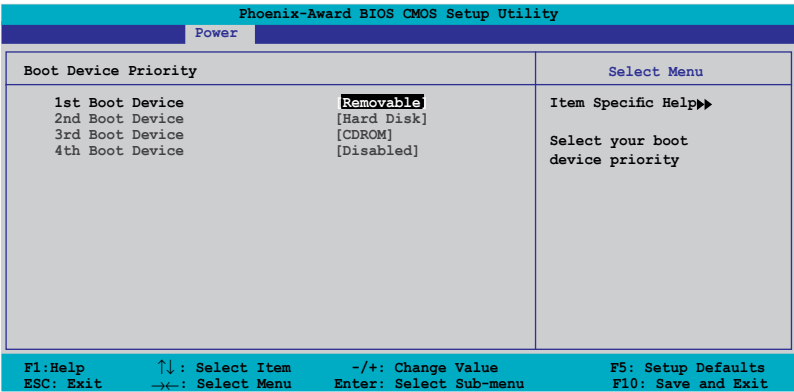

#### 1st ~ xxth Boot Device [Removable]

These items specify the boot device priority sequence from the available devices. The number of device items that appears on the screen depends on the number of devices installed in the system.

Configuration options: [Removable] [Hard Disk] [CDROM] [Disabled]

## 2.6.2 Removable Drives

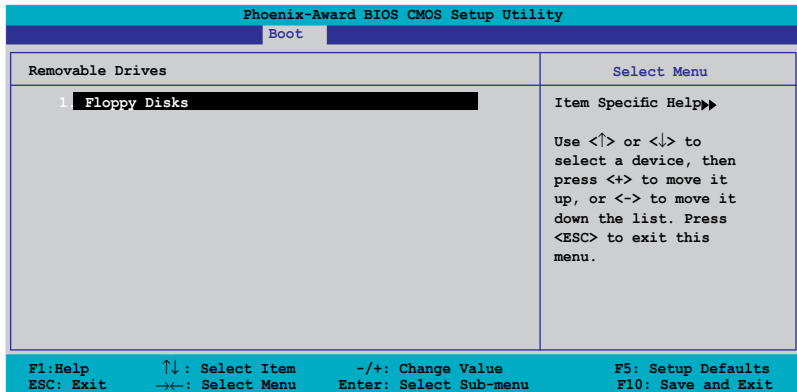

### 1. Floppy Disks

Allows you to assign a removable drive attached to the system.

## 2.6.3 Boot Settings Configuration

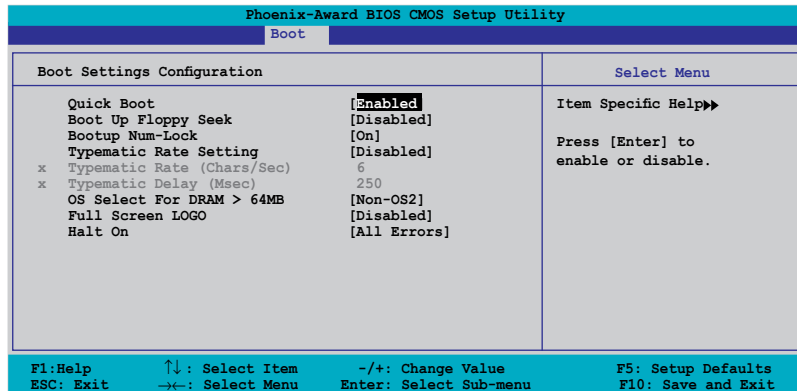

### Quick Boot [Enabled]

Allows you to enable or disable the system quick boot feature. When Enabled, the system skips certain tests while booting. Configuration options: [Disabled] [Enabled]

## Boot Up Floppy Seek [Disabled]

Enable this item to allow the BIOS to check a floppy drive during POST.  
Configuration options: [Disabled] [Enabled]

## Bootup Num-Lock [On]

Allows you to select the power-on state for the NumLock.  
Configuration options: [Off] [On]

## Typematic Rate Setting [Disabled]

Allows you to set the keystroke rate. Enable this item to configure the Typematic Rate (Chars/Sec) and the **Typematic Delay (Msec)**.  
Configuration options: [Disabled] [Enabled]



---

The items **Typematic Rate (Chars/Sec)** and **Typematic Delay (Msec)** becomes user-configurable only when the item Typematic Rate Setting is enabled.

---

## Typematic Rate (Chars/Sec) [6]

Allows you to select the rate at which a character repeats when you hold a key. Configuration options: [6] [8] [10] [12] [15] [20] [24] [30]

## Typematic Delay (Msec) [250]

Allows you to set the delay before keystrokes begin to repeat.  
Configuration options: [250] [500] [750] [1000]

## OS Select For DRAM > 64MB [Non-OS2]

Allows you to select the OS2 to operate system with greater than 64MB of RAM on the system. Configuration options: [Non-OS2] [OS2]

## Full Screen LOGO [Disabled]

Allows you to enable or disable the full screen logo display feature.  
Configuration options: [Disabled] [Enabled]



---

Make sure that the above item is set to [Enabled] if you want to use the ASUS MyLogo2™ feature.

---

## Halt On [All Errors]

Allows you to error report type.  
Configuration options: [All Errors] [No Errors] [All, But Keyboard]  
[All, But Diskette] [All, But Disk/Key]

## 2.6.4 Security

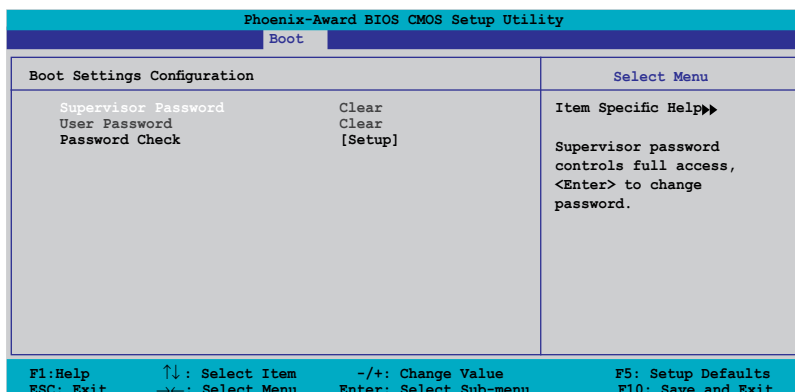

### Supervisor Password User Password

These fields allow you to set passwords:

To set a password:

1. Select an item then press <Enter>.
2. Type in a password using a combination of a maximum of eight (8) alpha-numeric characters, then press <Enter>.
3. When prompted, confirm the password by typing the exact characters again, then press <Enter>. The password field setting is changed to [Set].

To clear the password:

1. Select the password field and press <Enter> twice. The following message appears:



2. Press any key to continue. The password field setting is changed to Clear.

A note about passwords

The Supervisor password is required to enter the BIOS Setup program preventing unauthorized access. The User password is required to boot the system preventing unauthorized use.

Forgot your password?

If you forget your password, you can clear it by erasing the CMOS Real Time Clock (RTC) RAM. The RAM data containing the password information is powered by the onboard button cell battery. If you need to erase the CMOS RAM, refer to section “1.9 Jumpers” for instructions.

## Password Check

This field requires you to enter the password before entering the BIOS setup or the system. Select [Setup] to require the password before entering the BIOS Setup. Select [System] to require the password before entering the system.

Configuration options: [Setup] [System]

## 2.7 Tools menu

The Tools menu allows you to access special BIOS functions. Select an item then press <Enter> to display the sub-menu.

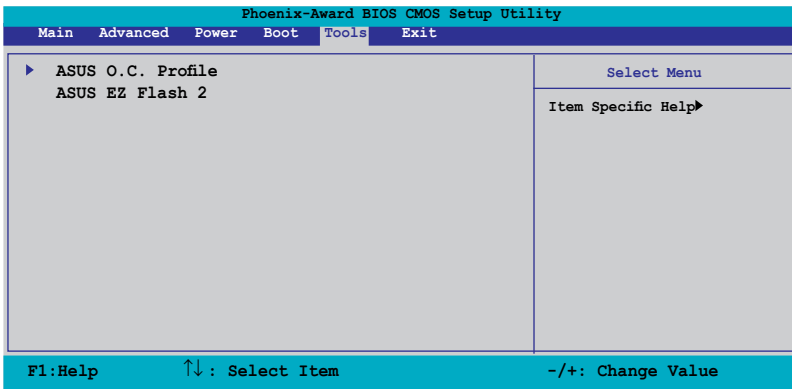



## 2.7.1 ASUS O.C. Profile

This item allows you to store or load multiple BIOS settings.

Phoenix-Award BIOS CMOS Setup Utility	
Tools	
ASUS O.C. Profile	Select Menu
▶ Load BIOS Profile ▶ Save BIOS Profile	Item Specific Help▶▶ Press [Enter] to select.

### Load BIOS Profile

Phoenix-Award BIOS CMOS Setup Utility	
Tools	
Load BIOS Profile	Select Menu
Load from Profile 1 Load from Profile 2 Load from File	Item Specific Help▶▶ Load BIOS Profile from Profile 1.

### Load from Profile 1/2

Allows you to load the previous BIOS settings saved in the BIOS Flash.  
Press <Enter> to load the file.

### Load from File

Allows you to load the previous BIOS file saved in the hard disk, floppy disk, or USB flash disk with a FAT32/16/12 format.

To load the BIOS file:

1. Insert the storage device that contains the “xxx.CMO” BIOS profile.
2. Turn on the system.
3. Enter BIOS setup program. Go to **Tools** then select **Load from File** and press <Enter>.
4. Press <Tab> to select the drive with the BIOS profile then press <Enter> to load file.
5. Follow message screen when loading is finished.



---

Update only a BIOS file coming from the same memory/CPU configuration and BIOS version.

---

# Save BIOS Profile

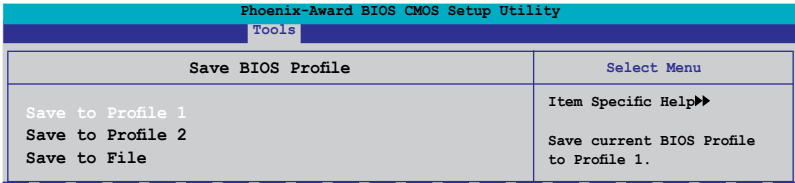

## Save to Profile 1/2

Allows you to save the current BIOS file to the BIOS Flash. Press <Enter> to save the file.

## Save to File

Allows you to save the current BIOS file to the hard disk, a floppy, or USB flash disk with a FAT32/16/12 format.

To save the BIOS file:

1. Insert the storage device with at least xxMB of available storage space.
2. Turn on the system.
3. Enter the BIOS setup program. Go to **Tool** then select **Save to File** and press <Enter>.
4. Press <Tab> to select the drive with the BIOS profile then press <Enter> to load file.
5. Follow message screen when loading is finished. A pop-up message will inform you when the saving process is finished.

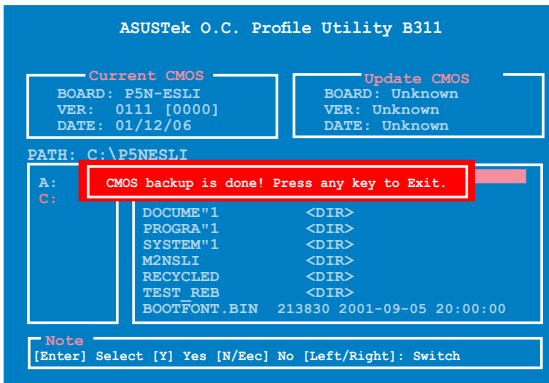

The BIOS file will be saved as "xxx.CMO".

## 2.7.2 ASUS EZ Flash 2

Allows you to run ASUS EZ Flash 2. Press <Enter> to start EZ Flash 2 then from the confirmation screen, use the left or right arrows to select [Yes] or [No] then press <Enter>.

The following screen appears if you select [Yes]. Follow screen instructions to flash the BIOS.

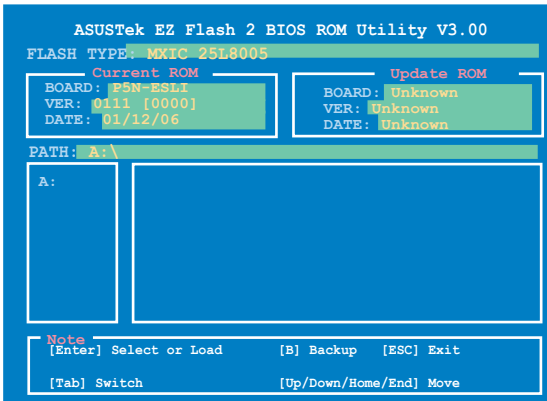

## 2.8 Exit menu

The Exit menu items allow you to load the optimal or failsafe default values for the BIOS items, and save or discard your changes to the BIOS items.

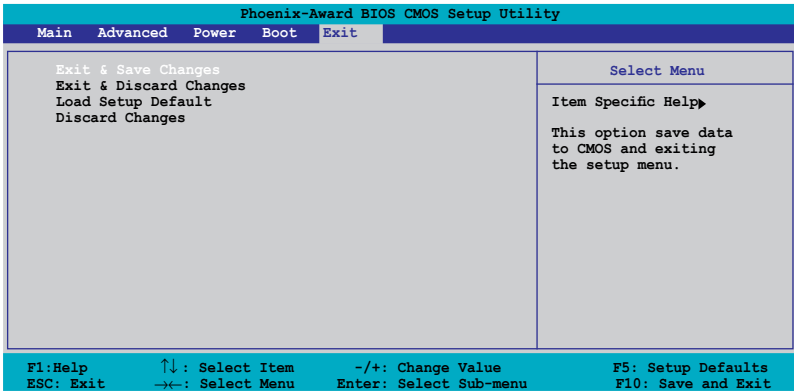

Pressing <Esc> does not immediately exit this menu. Select one of the options from this menu or <F10> from the legend bar to exit.

### Exit & Save Changes

Once you are finished making your selections, choose this option from the Exit menu to ensure the values you selected are saved to the CMOS RAM. An onboard backup battery sustains the CMOS RAM so it stays on even when the PC is turned off. When you select this option, a confirmation window appears. Select **Yes** to save changes and exit.



If you attempt to exit the Setup program without saving your changes, the program prompts you with a message asking if you want to save your changes before exiting. Press <Enter> to save the changes while exiting.

### Exit & Discard Changes

Select this option only if you do not want to save the changes that you made to the Setup program. If you made changes to fields other than System Date, System Time, and Password, the BIOS asks for a confirmation before exiting.

## Load Setup Defaults

This option allows you to load the default values for each of the parameters on the Setup menus. When you select this option or if you press <F5>, a confirmation window appears. Select **Yes** to load default values. Select **Exit & Save Changes** or make other changes before saving the values to the non-volatile RAM.

## Discard Changes

This option allows you to discard the selections you made and restore the previously saved values. After selecting this option, a confirmation appears. Select **Yes** to discard any changes and load the previously saved values.



This chapter describes the contents of the support CD that comes with the motherboard package.

# 3 Software support

### 3.1 Installing an operating system

This motherboard supports Windows® 2000/2003 Server/XP/64-bit XP operating systems (OS). Always install the latest OS version and corresponding updates to maximize the features of your hardware.



- Motherboard settings and hardware options vary. Use the setup procedures presented in this chapter for reference only. Refer to your OS documentation for detailed information.
- Make sure that you install Windows® 2000 Service Pack 4 or the Windows® XP Service Pack2 or later versions before installing the drivers for better compatibility and system stability.

### 3.2 Support CD information

The support CD that came with the motherboard package contains the drivers, software applications, and utilities that you can install to avail all motherboard features.



The contents of the support CD are subject to change at any time without notice. Visit the ASUS website([www.asus.com](http://www.asus.com)) for updates.

#### 3.2.1 Running the support CD

Place the support CD to the optical drive. The CD automatically displays the Drivers menu if Autorun is enabled in your computer.



Click an icon to display support CD/motherboard information

Click an item to install



If Autorun is NOT enabled in your computer, browse the contents of the support CD to locate the file ASSETUP.EXE from the BIN folder. Double-click the **ASSETUP.EXE** to run the CD.



## 3.2.2 Drivers menu

The drivers menu shows the available device drivers if the system detects installed devices. Install the necessary drivers to activate the devices.



### **ASUS InstAll-Drivers Installation Wizard**

Installs all of the drivers through ASUS InstAll-Installation wizard.

### **nVidia Chipset Driver Program**

Installs the NVIDIA® Chipset drivers for the NVIDIA® nForce™ 650i SLI chipset.

### **Realtek Audio Driver**

Installs the Realtek audio controller and application.

### **JMicron JMB36X RAID Controller Driver**

Installs the JMicron JMB36X RAID Controller driver.

### **USB 2.0 Driver**

Installs the Universal Serial Bus 2.0 (USB 2.0) driver.

### 3.2.3 Utilities menu

The Utilities menu shows the applications and other software that the motherboard supports.



#### ASUS InstAll-Installation Wizard for Utilities

Install all of the utilities through the Installation Wizard.

#### ADOBE Acrobat Reader V7.0

Installs the Adobe® Acrobat® Reader V7.0 that allows you to open, view, and print documents in Portable Document Format (PDF).

#### ASUS Update

Allows you to download the latest version of the BIOS from the ASUS website.



---

Before using the ASUS Update, make sure that you have an Internet connection so you can connect to the ASUS website.

---

#### ASUS PC Probe II

This smart utility monitors the fan speed, CPU temperature, and system voltages, and alerts you of any detected problems. This utility helps you keep your computer in healthy operating condition.

## Microsoft DirectX 9.0c

Installs the Microsoft® DirectX 9.0c driver. The Microsoft DirectX® 9.0c is a multimedia technology that enhances computer graphics and sound. DirectX® improves the multimedia features of your computer so you can enjoy watching TV and movies, capturing videos, or playing games in your computer. Visit the Microsoft website ([www.microsoft.com](http://www.microsoft.com)) for updates.

## Anti-virus Utility

The anti-virus application scans, identifies, and removes computer viruses. View the online help for detailed information.

### 3.2.4 Make Disk menu

The Make Disk menu contains items to create the NVIDIA® nForce™ 4 SATA RAID driver disk.



#### NVIDIA 32bit SATA RAID Driver

Creates the NVIDIA® 32bit driver disk for Serial ATA RAID features.

#### NVIDIA 64bit SATA RAID Driver

Creates the NVIDIA® 64bit driver disk for Serial ATA RAID features.

## JMicron JMB36X 32bit RAID Driver

Creates the JMicron JMB36X 32bit RAID Driver.

## JMicron JMB36X 64bit RAID Driver

Creates the JMicron JMB36X 64bit RAID Driver.

### 3.2.5 Manuals menu

The Manuals menu contains a list of supplementary user manuals. Click an item to open the folder of the user manual.



- Most user manual files are in Portable Document Format (PDF). Install the Adobe® Acrobat® Reader from the Utilities menu before opening a user manual file.
- Some user manuals listed in this menu may not be applicable for this motherboard model.



#### NVIDIA RAID User's Guide

Allows you to open the Nvidia® RAID user guide.

#### Realtek HDA Audio User's Manual

Allows you to open the Realtek® HDA Audio User's Manual.

### JMicron JMB36X RAID AP User's Manual

Allows you to open the JMicron JMB36X RAID AP User's Manual.

### JMicron JMB36X RAID BIOS User's Manual

Allows you to open the JMicron JMB36X RAID BIOS User's Manual.

## 3.2.6 ASUS Contact information

Click the Contact tab to display the ASUS contact information. You can also find this information on the inside front cover of this user guide.



## 3.3 NVIDIA® SLI™ technology

The motherboard supports the NVIDIA® SLI™ (Scalable Link Interface) technology that allows you to install two identical PCI Express™ x16 graphics cards. Follow the installation procedures in this section.

### 3.3.1 Requirements

- You should have two identical SLI-ready graphics cards that are NVIDIA® certified.
- Visit the ASUS website ([www.asus.com](http://www.asus.com)) for a list of qualified SLI-ready graphics cards for this motherboard.
- Make sure that your graphics card driver supports the NVIDIA SLI technology. Download the latest driver from the NVIDIA website ([www.nvidia.com](http://www.nvidia.com)).
- Make sure that your power supply unit (PSU) can provide at least the minimum power required by your system. See “10. ATX power connectors” on page 1-34 for details.



- 
- The NVIDIA SLI technology supports Windows® XP™ operating system only.
  - Visit the NVIDIA website for the supported 3D applications.
  - Visit the NVIDIA zone website (<http://www.nzone.com>) for the latest certified graphics card list.
-

## 3.3.2 Dual graphics card setup

### Setting the ASUS EZ selector card

Your motherboard package comes with a pre-installed ASUS EZ selector card. By default, the card is set for a single graphics card. To use two graphics cards on this motherboard, you must first set the selector card to Dual Video Cards.



To set the selector card:

1. Locate the selector card on the motherboard.

Pre-installed  
ASUS EZ  
selector card

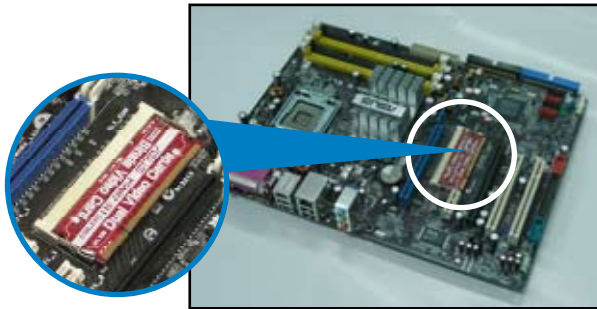

2. Simultaneously push the retention clips outward to release the card.

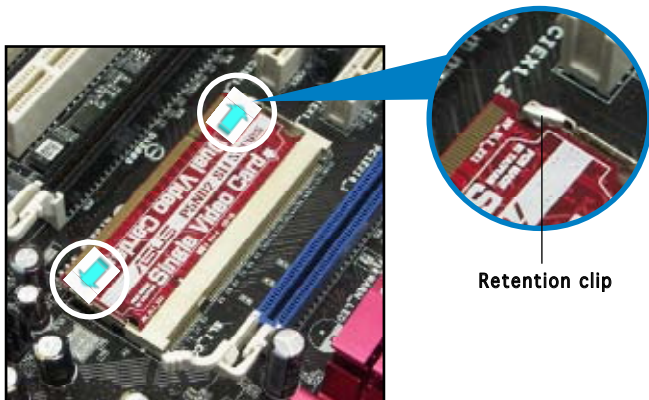

- 3. When released, pull the selector card out of the slot.

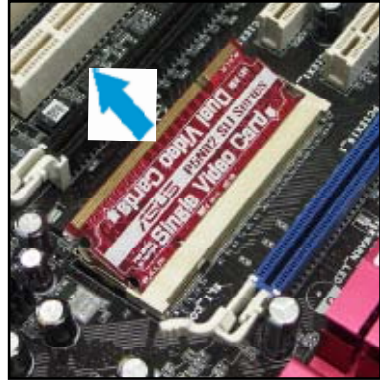

- 4. Invert the selector card and insert the edge labeled Dual Video Cards.

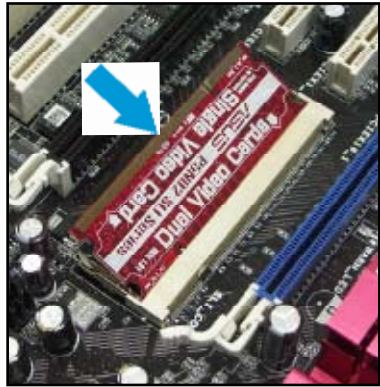

- 5. Push down the selector card until the retention clips snap into place.



Make sure to completely insert the selector card into the slot.

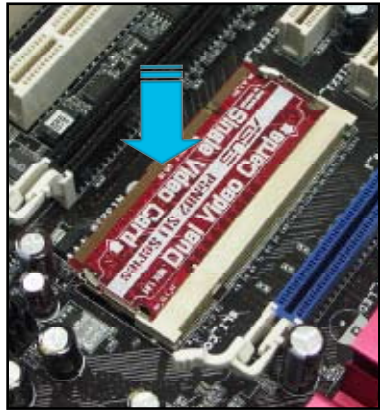



## Installing SLI-ready graphics cards



Install only identical SLI-ready graphics cards that are NVIDIA® certified. Different types of graphics cards will not work together properly.

To install the graphics cards:

1. Prepare two graphics cards. Each graphics card should have goldfingers for the SLI connector.

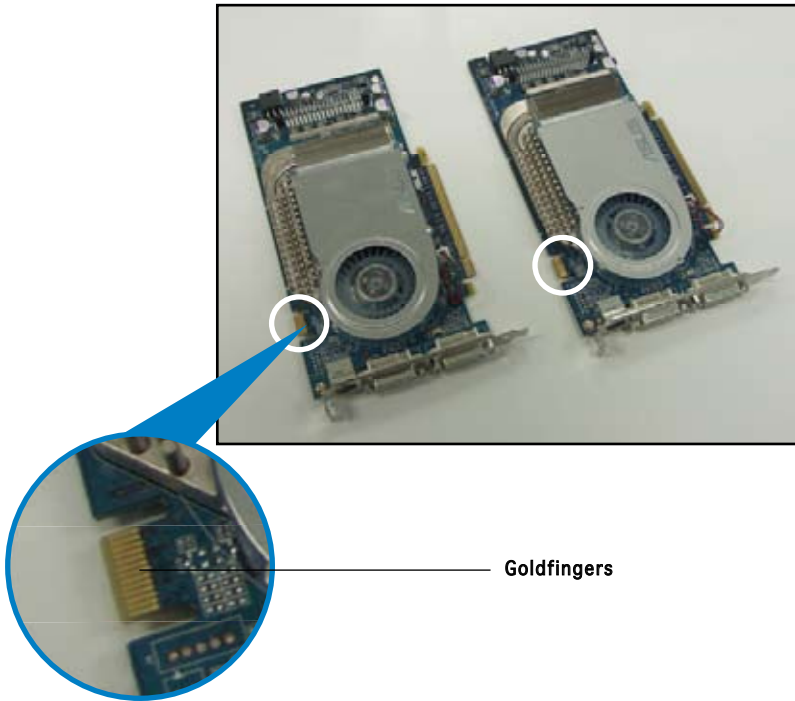

2. Remove the metal bracket covers opposite the two PCI Express x16 slots.

3. Insert one graphics card into the blue slot labeled **PCIEX16\_1**. Make sure that the card is properly seated on the slot.

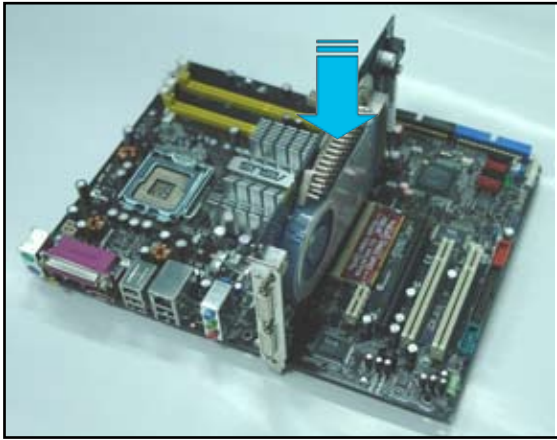

4. Insert the second graphics card into the black slot labeled **PCIEX16\_2**. Make sure that the card is properly seated on the slot.



---

If required, connect an auxiliary power source to the PCI Express graphics cards.

---

5. Align and insert the SLI flexible cable connector to the goldfingers on each graphics card. Make sure that the connector is firmly in place.

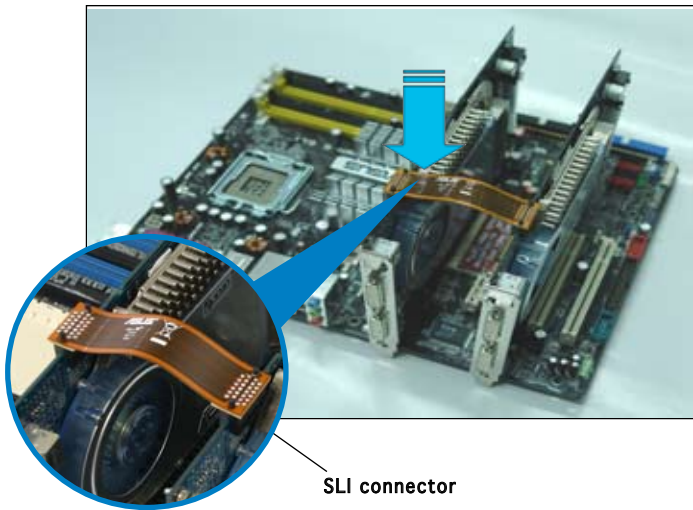

6. Connect a VGA cable or a DVI-I cable to the graphics card installed on the blue PCI Express slot.

## Installing the device drivers

Refer to the documentation that came with your graphics card package to install the device drivers.



---

Make sure that your PCI Express graphics card driver supports the NVIDIA SLI technology. Download the latest driver from the NVIDIA website ([www.nvidia.com](http://www.nvidia.com)).

---

# Enabling the multi-GPU feature in Windows

After installing your graphics cards and the device drivers, enable the Multi-Graphics Processing Unit (GPU) feature in the NVIDIA nView properties.

To enable the multi-GPU feature:

- 1. Click the **NVIDIA Settings icon** on your Windows taskbar.



NVIDIA Settings icon

- 2. From the pop-up menu, select **nView Desktop Manager** then click **nView Properties**.

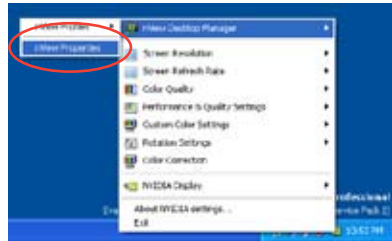

- 3. From the nView Desktop Manager window, select the **Desktop Management** tab.
- 4. Click **Properties** to display the Display Properties dialog box.



- From the Display Properties dialog box, select the **Settings** tab then click **Advanced**.



- Select the **NVIDIA GeForce** tab.



- Click the slider to display the following screen, then select the **SLI multi-GPU** item.

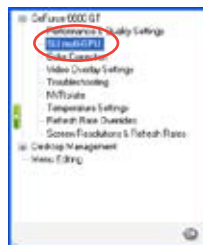

Slider



8. Click the **Enable SLI multi-GPU** check box.
9. Click **OK** when done.

## 3.4 Creating a RAID driver disk

A floppy disk with the RAID driver is required when installing Windows® 2000/XP operating system on a hard disk drive that is included in a RAID set.

To create a RAID driver disk:

1. Place the motherboard support CD into the CD-ROM drive.
2. Select **Make Disk** tab.
3. From the Make Disk menu, select the **RAID driver disk** you want to create or browse the contents of the support CD to locate the driver disk utility.



---

For detailed descriptions on the NVIDIA® RAID configuration, refer to the “NVIDIA® MediaShield RAID User’s Manual” found in your motherboard support CD .

---

4. Insert floppy disk to floppy disk drive.
5. Follow succeeding screen information to complete process.
6. Write-protect the floppy disk to avoid computer virus infection.

To install the RAID driver:

1. During the OS installation, the system prompts you to press the **F6** key to install third-party SCSI or RAID driver.
2. Press <**F6**> then insert the floppy disk with RAID driver into the floppy disk drive.
3. Follow the succeeding screen instructions to complete the installation.



---

Due to chipset limitation, the Serial ATA ports supported by the NVIDIA chipset doesn’t support Serial Optical Disk Drives (Serial ODD) under DOS.

---

The Appendix describes the CPU features that the motherboard supports.

# CPU features **A**

## A.1 Intel® EM64T

---



- The motherboard is fully compatible with Intel® Pentium® 4 LGA775 processors running on 32-bit operating systems.
  - The motherboard comes with a BIOS file that supports EM64T. You can download the latest BIOS file from the ASUS website ([www.asus.com/support/download/](http://www.asus.com/support/download/)) if you need to update the BIOS file. See Chapter 2 for details.
  - Visit [www.intel.com](http://www.intel.com) for more information on the EM64T feature.
  - Visit [www.microsoft.com](http://www.microsoft.com) for more information on Windows® 64-bit OS.
- 

### Using the Intel® EM64T feature

To use the Intel® EM64T feature:

1. Install an Intel® Pentium® 4 CPU that supports the Intel® EM64T.
  2. Install a 64-bit operating system (Windows® XP Professional x64 Edition or Windows® Server 2003 x64 Edition).
  3. Install the 64-bit drivers for the motherboard components and devices from the support CD.
  4. Install the 64-bit drivers for expansion cards or add-on devices, if any.
- 



Refer to the expansion card or add-on device(s) documentation, or visit the related website, to verify if the card/device supports a 64-bit system.

---

## A.2 Enhanced Intel SpeedStep® Technology (EIST)

---



- The motherboard comes with a BIOS file that supports EIST. You can download the latest BIOS file from the ASUS website ([www.asus.com/support/download/](http://www.asus.com/support/download/)) if you need to update the BIOS. See Chapter 2 for details.
  - Visit [www.intel.com](http://www.intel.com) for more information on the EIST feature.
- 

### A.2.1 System requirements

Before using EIST, check your system if it meets the following requirements:

- Intel® Pentium® 4 processor with EIST support
- BIOS file with EIST support
- Operating system with EIST support (Windows® XP SP2/Windows® Server 2003 SP1/Linux 2.6 kernel or later versions)



## A.2.2 Using the EIST

To use the EIST feature:

1. Turn on the computer, then enter the BIOS Setup.
2. Go to the Advanced Menu, highlight CPU Configuration, then press <Enter>.
3. Set the Intel(R) SpeedStep Technology item to [Automatic], then press <Enter>. See page 2-27 for details.
4. Press <F10> to save your changes and exit the BIOS setup.
5. After the computer restarts, right click on a blank space on the desktop, then select Properties from the pop-up menu.
6. When the Display Properties window appears, click the Screen Saver tab.
7. Click the Power button on the Monitor power section to open the Power Options Properties window.

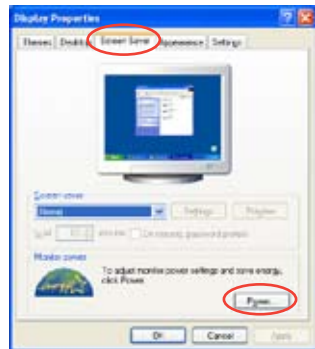

8. On the Power schemes section, click , then select any option except Home/Office Desktop or Always On.
9. Click Apply, then click OK.
10. Close the Display Properties window.

After you adjust the power scheme, the CPU internal frequency slightly decreases when the CPU loading is low.

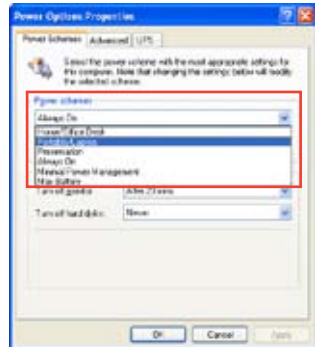

The screen displays and procedures may vary depending on the operating system.

## A.3 Intel® Hyper-Threading Technology

---



- The motherboard supports Intel® Pentium® 4 LGA775 processors with Hyper-Threading Technology.
  - Hyper-Threading Technology is supported under Windows® XP/2003 Server and Linux 2.4.x (kernel) and later versions only. Under Linux, use the Hyper-Threading compiler to compile the code. If you are using any other operating systems, disable the Hyper-Threading Technology item in the BIOS to ensure system stability and performance.
  - Installing Windows® XP Service Pack 1 or later version is recommended.
  - Make sure to enable the Hyper-Threading Technology item in BIOS before installing a supported operating system.
  - For more information on Hyper-Threading Technology, visit [www.intel.com/info/hyperthreading](http://www.intel.com/info/hyperthreading).
- 

### Using the Hyper-Threading Technology

To use the Hyper-Threading Technology:

1. Install an Intel® Pentium® 4 CPU that supports Hyper-Threading Technology.
2. Power up the system and enter the BIOS Setup. Under the Advanced Menu, make sure that the item Hyper-Threading Technology is set to Enabled.

The BIOS item appears only if you installed a CPU that supports Hyper-Threading Technology.